

RS485 NETWORK MODULE INSTRUCTION MANUAL



SCM-NM

General

The Smart Connect Multi-loop system network has the facility to monitor, indicate and control the functions of a fire alarm installation, thus allowing signals to be distributed around a large site. The network will accommodate up to 64 nodes. The network uses RS485 data communication and a total network cable length of up to 10km is possible. All panels will continue to function in stand-alone mode, even if the network fails. On a Smart Connect Multi-loop running in a network, all events are reported at all panels and all panels are able to remotely program other panels sitting on the network. Operation of outputs over the network is determined by the programmed cause & effects. Any input on the network can be programmed to operate any output.

Installation



ATTENTION: THE PANEL MUST BE POWERED DOWN AND DISCONNECTED FROM THE BATTERIES BEFORE INSTALLING OR REMOVING ANY MODULES.

1. Ensure that the installation area is free from any cables or wires that may get caught, and that there is enough space on the DIN rail to mount the module. Also ensure that the DIN clip underneath the module is in the open position.
2. Place the module onto the DIN rail, hooking the metal earth clip underneath onto the rail first.
3. Once the earth clip is hooked, push the bottom of the module onto the rail so that the module sits flat.
4. Push the plastic DIN clip (located at the bottom of the module) upwards to lock and secure the module into position.

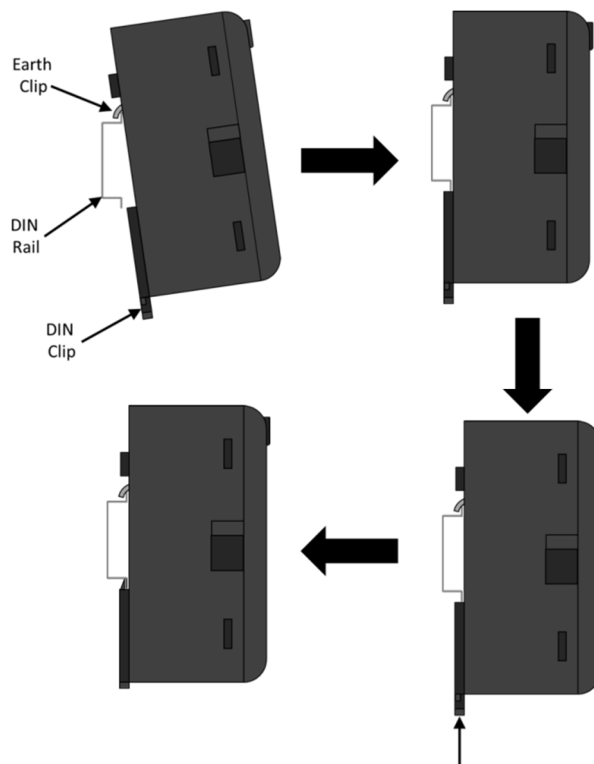

5. Once the module is secured to the DIN rail, simply connect the supplied CAT5E cable to the module's RJ45 port.
6. Connect the other end of CAT5E cable to the nearest unoccupied RJ45 port on the termination PCB.

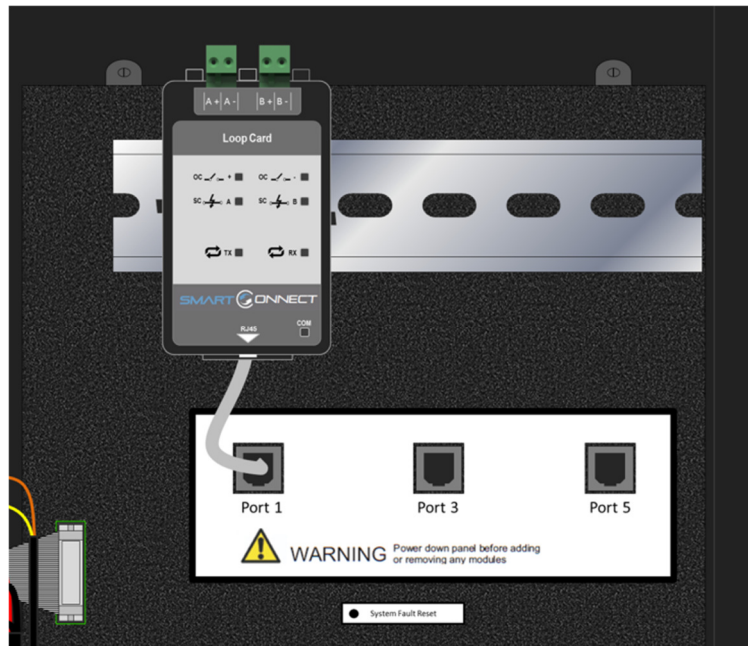

TRM RJ45 Port Address Designation

Each RJ45 port on the Smart Connect Multi-loop termination has its own unique port address. This port address is important to keep note of as it is displayed on Alarm/Fault messages and is used when configuring or setting up cause and effects on the panel (See SCM operation manual GLT-261-7-11).

Securing the modules

The modules are designed to clip together to make them more secure. In addition, the Smart Connect Multi-loop panel is supplied with Din rail stoppers. These should be fitted before the first module, and after the last module on each rail.



Before Powering the Panel On

1. To prevent the risk of a spark, do not connect the batteries. Only connect the batteries after powering on the system from its main AC supply.
2. Check that all external field wiring is clear from any open, shorts and ground faults.
3. Check that all the modules have been installed properly, with correct connections and placement
4. Check that all switches and jumper links are at their correct settings.
5. Check that all interconnection cables are plugged in properly, and that they are secure.
6. Check that the AC power wiring is correct.
7. Ensure that the panel chassis has been correctly earth grounded.

Before powering on from the main AC supply, make sure that the front panel door is closed

Power on Procedure

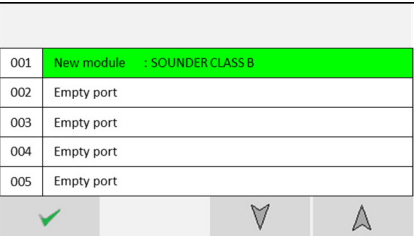
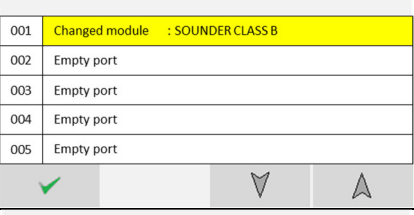
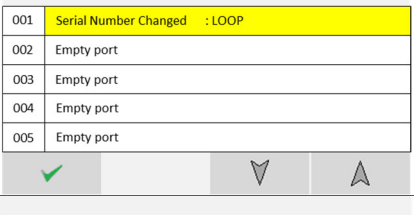
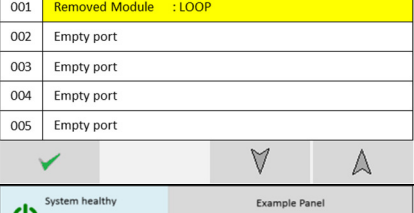
1. After the above has been completed, turn the panel on (Via AC Only). The panel will follow the same power up sequence described in initial power up section above
2. The panel will now display one of the following messages

Message	Meaning
 <p style="text-align: center;">No Modules</p>	<p>Panel has not detected any modules fitted during its power up check.</p> <p>Power down the panel and check that the expected modules are fitted, and that all module cables are correctly inserted.</p> <p>Note that the panel will need at least one module fitted to run.</p>
	<p>The panel has detected a new module added to a port that was previously empty.</p> <p>This is the usual message seen the first time a panel is configured</p>
	<p>The panel has detected a different type of module fitted to a port that was previously occupied.</p>
	<p>The panel has detected a module fitted to a port that is the same type, but it's serial number has changed.</p> <p>This could happen if a loop module was swapped with another one, for example.</p>
	<p>The panel has detected no module fitted to a port that was previously occupied.</p>
	<p>The panel has detected no module changes, so has powered up and started running</p>

1. Check that the module configuration is as expected using the ▲ and ▼ to navigate the through the port numbers. Press the ✓ icon to confirm the changes.
2. The new module is now configured into the panel and is ready for use.
3. Since the batteries are not connected, the panel will report them as removed, lighting the yellow “Fault” LED, intermittently sounding the Fault buzzer, and displaying battery removed message on the screen.
4. Connect the batteries, ensuring that the polarity is correct (Red wire = +ve) & (Black wire = -ve). Acknowledge the Fault event via the display screen, and reset the panel to clear the battery fault.
5. The panel should now remain in the normal condition, and you can configure the panel as normal.

Field Wiring



NOTE: The terminal blocks are removable to make wiring easier.



ATTENTION: DO NOT EXCEED POWER SUPPLY RATINGS, OR MAXIMUM CURRENT RATINGS.

Bus Topology

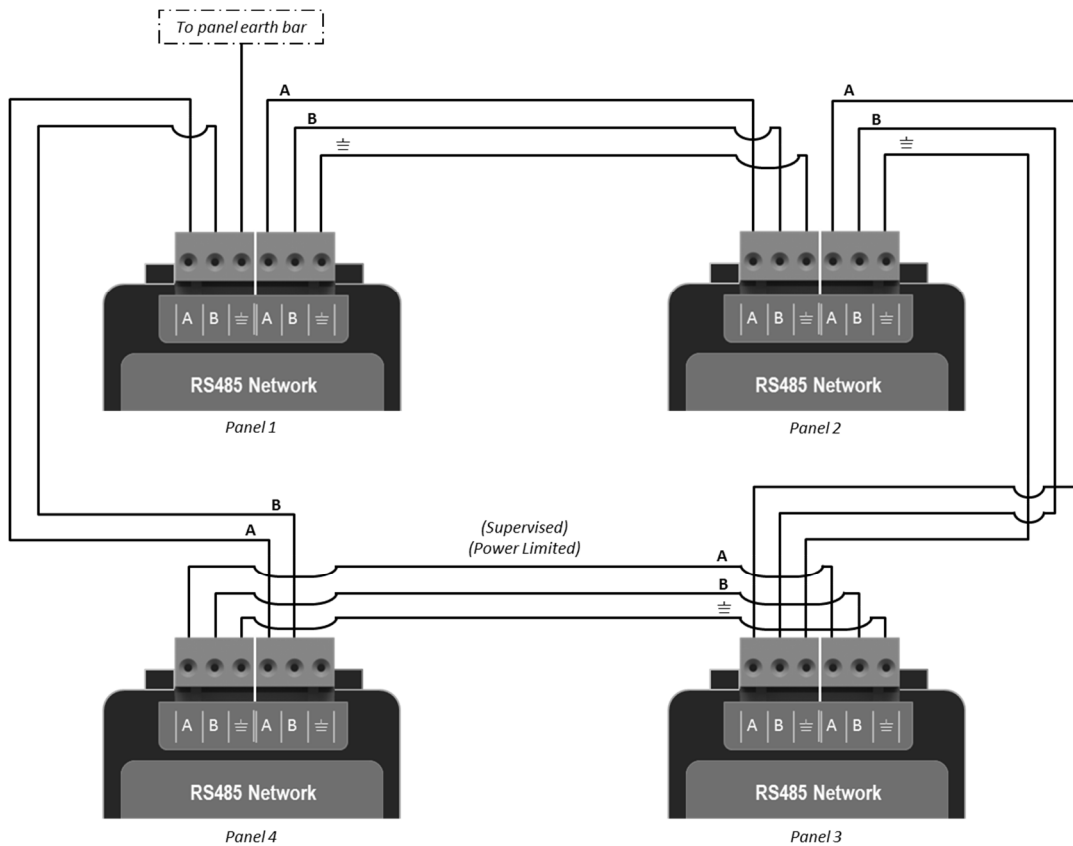

Ring Topology

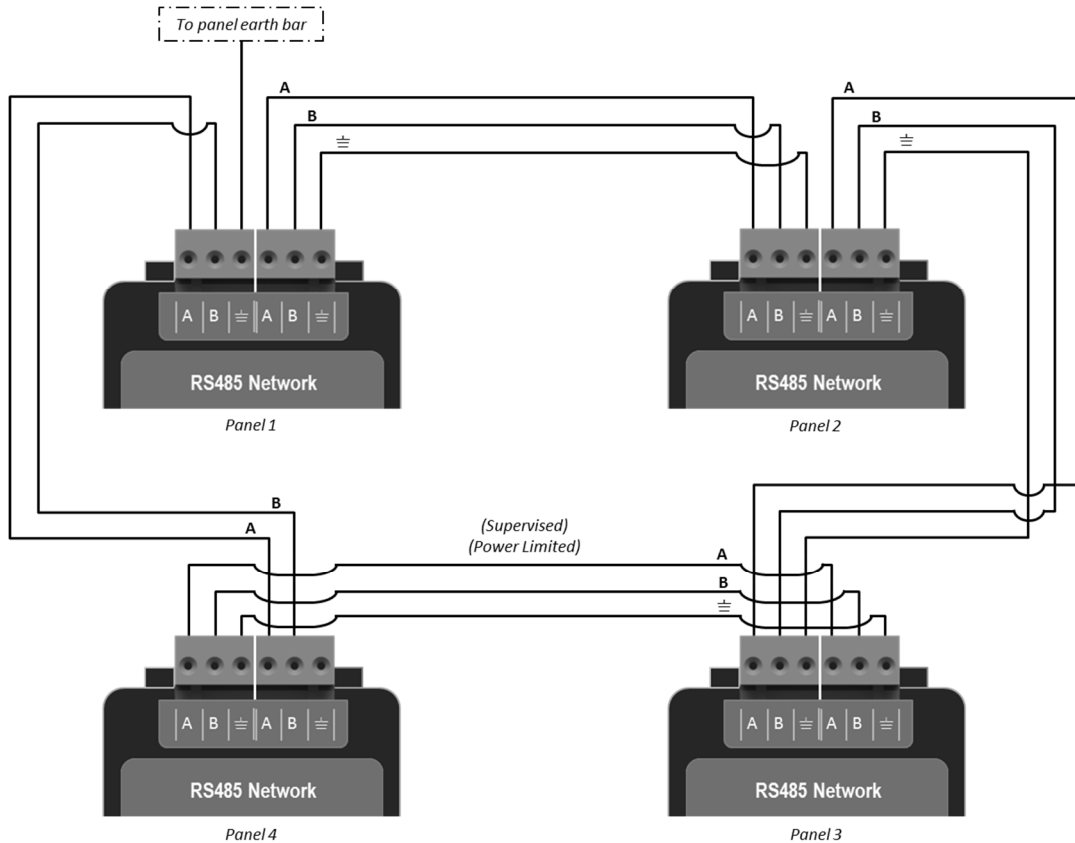

i **NOTE:** It is recommended to install the network in a ring topology for protection against open circuit and short circuit faults.

i **NOTE:** Star topology not supported

Wiring recommendations

The Smart Connect Multi-loop network can support up to 64 panels. Maximum distance between nodes:-





*100M using standard fireproof cable

1KM using a screened data cable

i **RECOMMENDED CABLE:** Belden type Screened twisted pair

*BS 5839-1:2017 requires that network cable be standard fireproof cable (enhanced fire proof cable may be required for specified installations).

Front Unit LED Indications

LED Indication	Description	LED Indication	Description
	Flashing yellow when a fault on the RS485 circuit is detected.		Flashing green when the RS485 is receiving information.
	Flashing green when the RS485 is transmitting information.		Pulses to show communication between the module and the motherboard.

Specifications

Specification	SCM-NM
Design Standard	EN54-2
Approval	LPCB (Pending)
Quiescent Current	15mA
Alarm Current	17mA
Communication Protocol	RS485 (115,200 Baud)
Maximum Network Size	64 Nodes
Maximum Distance Between Nodes (for Bus or Ring*)	1KM (<i>using a screened data cable</i>) 100M (<i>using a standard fireproof cable</i>)
Network Wiring Typologies	Bus Ring (<i>recommended</i>)
Operating Temperature	-5°C (23°F) to 40°C (104°F)
Max Humidity	93% Non-Condensing
Size (mm) (HxWxD)	105mm x 57mm x 47mm
Weight	0.15KG
Recommended Cable	Belden Screened Data Cable or Equivalent

*In a SCM Network, each network card just communicates to its neighbours. The neighbours will then pass on the message if it is not intended for them, so each panel only communicates one node length.