

SMART10-P - SmartConnect 10 Port Control Panel with On Board Printer

The new range of intelligent Smart Connect Multi-Loop panels from Zeta Alarms Systems are designed to be flexible not only in the design, but also in the installation of any fire alarm system.

EN54 parts 2 & 4 approved, these multifunctioning range of panels will provide the perfect solutions for any conventional system configuration, just allow the system to build itself, **it's that simple**

Multiple Loop, Multi Configuration Panel

10 Module Ports Available - Just add the Conventional Panel Modules (below)



Description

The SmartConnect is a powerful and sophisticated fire alarm control panel that offers a variety of modular components, allowing the panel to adapt to a wide variety of applications.

Key Features

- TCP IP interface and alarm manager interface
- Modular Construction allows a panel to be specified using just the required modules
- 4.3 inch Colour touch screen display
- On Board Printer
- 64 LED Zone Front of panel indication
- Capacity for up to 10 Smart Connect modules
- Full case & effect programming via front panel
- Up to 64 panel peer-2-peer network



Conventional Panel Modules

Flexibility is the key....

Up to 7 modules to utilise, any quantity, any configuration

A range of interchangeable panel modules designed to be DIN mounted inside the SmartConnect panels, allowing different configuration arrangements when designing the requires system

SCM-ZMM

Zone Monitor Module



The SCM-ZMM is a Class B six zone monitor module that is designed to be DIN mounted inside a Smart Connect control panel

Allows 32 devices per zone

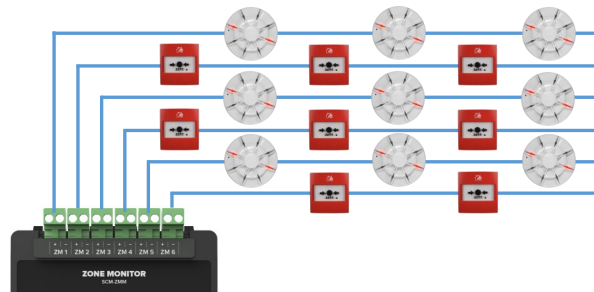

SCM-ACM

Alarm Circuit Module



The SCM-ACM provides power for and handles communications to the conventional sounder & strobe appliances.

It has 2 Class B circuits with the ability of powering up to a maximum 500mA per circuit.

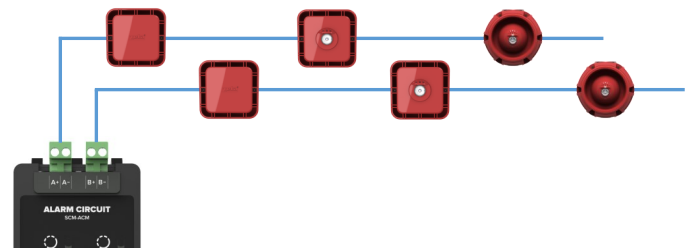

SCM-NM NetWork Module



The SCM-NM module ensures the Smart Connect system network has the facility to monitor, indicate and control the functions of a fire alarm installation, thus allowing signals to be distributed around a large site.

The Network will accommodate up to 64 nodes



SCM-RM Relay Output Module



The SCM-RM has 3 onboard relays which can be typically used to control additional auxiliary equipment. Each relay can be programmed to activate on alarm, supervisory, or trouble.

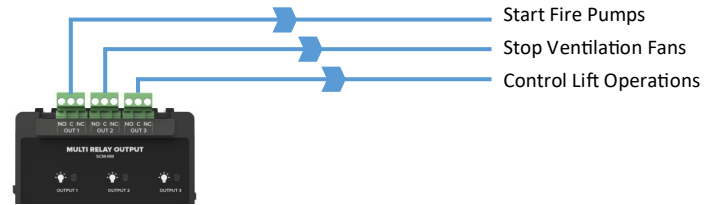

SCM-MIM NetWork Module



The SCM-MIM has six class B inputs that are commonly used to monitor and raise alarms from any specific ancillary equipment.

Each Input is monitored for open or short circuits and can also be programmed to give a supervisory or alarm signal when active.

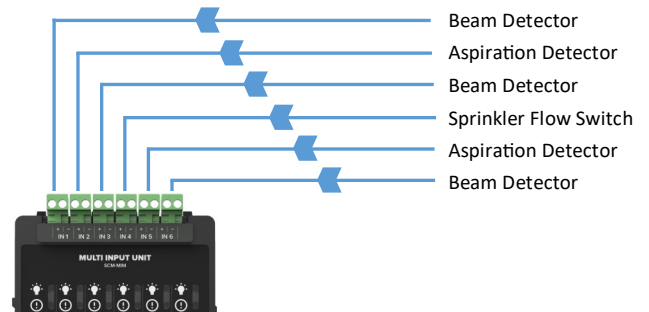

SCM-LAN-TCP/IP TCP/IP Module



The SCM-LAN module provides the interface allowing connection into a Local area network (LAN).

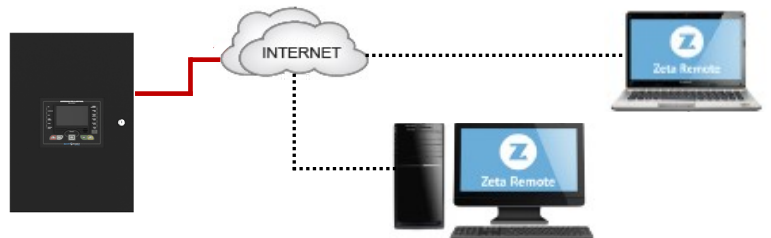

SCM-PM Printer Module



The SCM-PM is a RS232 module gives the ability to interface to RS232 serial equipment and devices.

This is most commonly used to connect to a desktop printer for real time event log printing

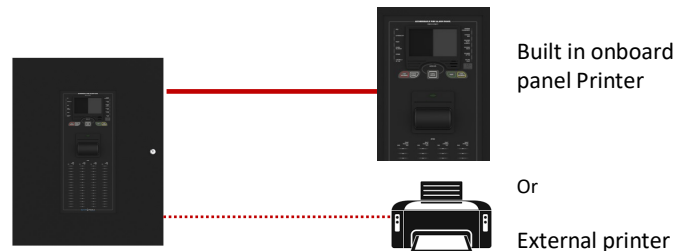

Module Configuration Options - When mounting inside the panel

Top Row - Din Rail Mount



3 Large & 1 Small Module



1 Large & 4 Small Modules



5 Small Modules

Bottom Row - Din Rail Mount



3 Large Modules



1 Large & 4 Small Modules



5 Small Modules

System Configuration Options

1-6 Zones with printer and a sounder circuit module

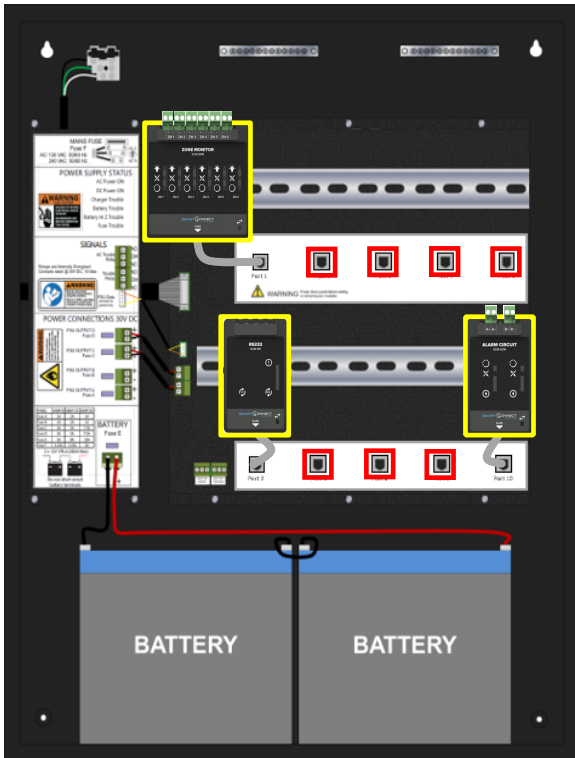

Required Modules for configuration
 Available Ports to add modules

Required



SCM-ZMM
Zone Monitor
Module

x1

Required



SCM-ACM
Alarm Circuit
Module

x1

Required



SCM-PM
Printer
Module

x1

7 Ports will still be available
Allowing additional system requirements



SCM-NM
Network
Module



SCM-LAN
TCP/IP
Module



SCM-RM
Relay
Module



SCM-MIM
Multi Input
Module

1-6 Zones with printer, a sounder circuit module and networked

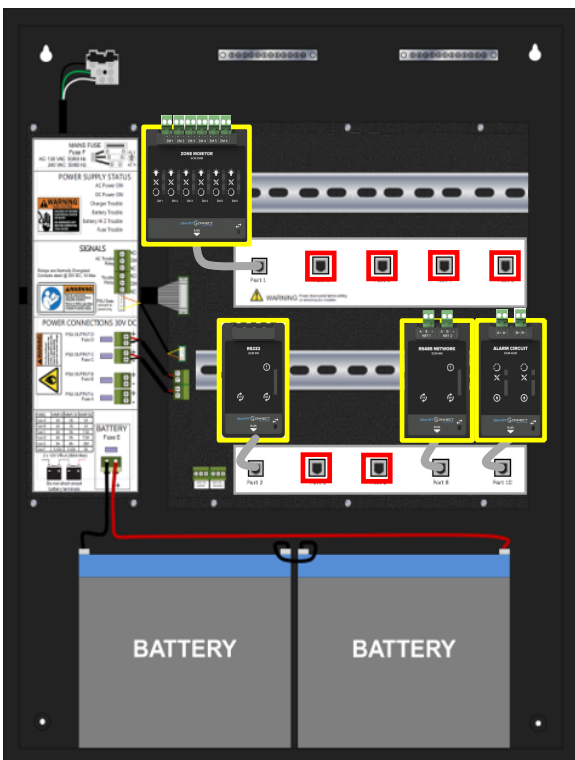

Required Modules for configuration
 Available Ports to add modules

Required



SCM-ZMM
Zone Monitor
Module

x1

Required



SCM-ACM
Alarm Circuit
Module

x1

Required



SCM-PM
Printer
Module

x1



SCM-NM
Network
Module

x1



SCM-LAN
TCP/IP
Module



SCM-RM
Relay
Module



SCM-MIM
Multi Input
Module





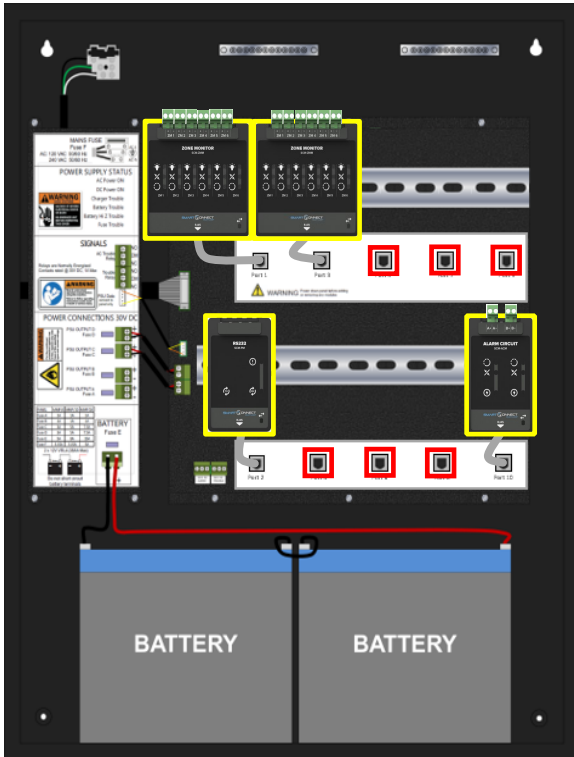

6 Ports will still be available
Allowing additional system requirements

System Configuration Options

1-12 Zones with printer and a sounder circuit module







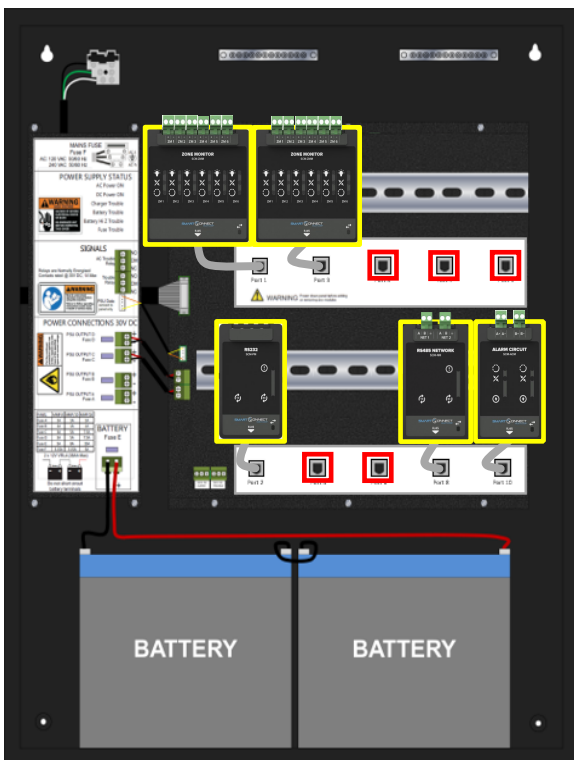

Required Modules for configuration
 Available Ports to add modules

<p>Required</p>  <p>SCM-ZMM Zone Monitor Module</p> <p style="text-align: right;">x2</p>	<p>Required</p>  <p>SCM-ACM Alarm Circuit Module</p> <p style="text-align: right;">x1</p>	
<p>Required</p>  <p>SCM-PM Printer Module</p> <p style="text-align: right;">x1</p>	<p>6 Ports will still be available Allowing additional system requirements</p>	
 <p>SCM-NM Network Module</p>		 <p>SCM-LAN TCP/IP Module</p>
 <p>SCM-RM Relay Module</p>	 <p>SCM-MIM Multi Input Module</p>	

1-12 Zones with printer, a sounder circuit module and networked



Required Modules for configuration
 Available Ports to add modules

<p>Required</p>  <p>SCM-ZMM Zone Monitor Module</p> <p style="text-align: right;">x2</p>	<p>Required</p>  <p>SCM-ACM Alarm Circuit Module</p> <p style="text-align: right;">x1</p>
<p>Required</p>  <p>SCM-PM Printer Module</p> <p style="text-align: right;">x1</p>	<p>Required</p>  <p>SCM-NM Network Module</p> <p style="text-align: right;">x1</p>
<p>5 Ports will still be available Allowing additional system requirements</p>	
 <p>SCM-LAN TCP/IP Module</p>	
 <p>SCM-RM Relay Module</p>	 <p>SCM-MIM Multi Input Module</p>

System Configuration Options

1-18 Zones with printer and a sounder circuit module

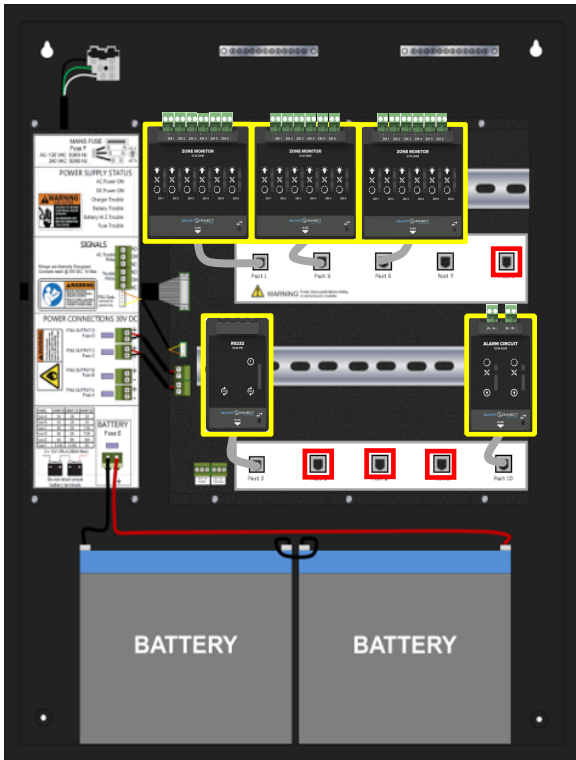

Required Modules for configuration
 Available Ports to add modules

Required



**SCM-ZMM
Zone Monitor
Module**

x3

Required



**SCM-ACM
Alarm Circuit
Module**

x1

Required



**SCM-PM
Printer
Module**

x1

4 Ports will still be available
Allowing additional system requirements



**SCM-NM
Network
Module**



**SCM-LAN
TCP/IP
Module**



**SCM-RM
Relay
Module**



**SCM-MIM
Multi Input
Module**

1-18 Zones with printer, a sounder circuit module and networked

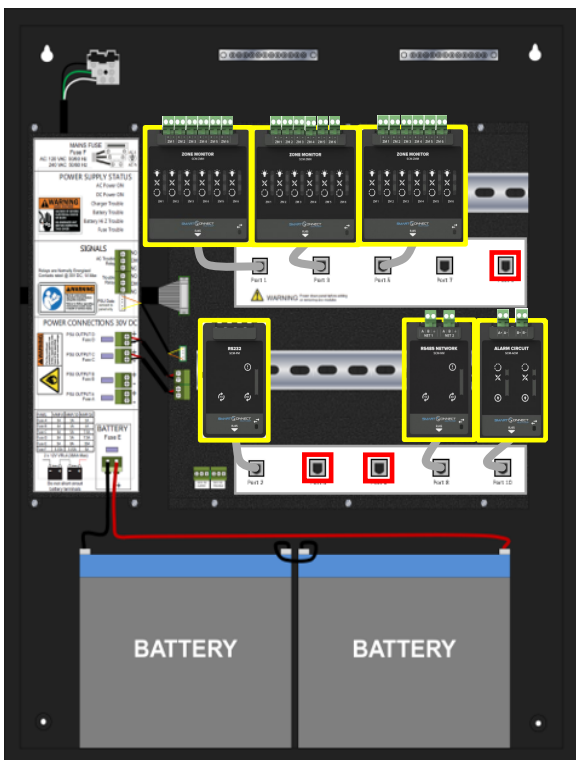

Required Modules for configuration
 Available Ports to add modules

Required



**SCM-ZMM
Zone Monitor
Module**

x3

Required



**SCM-ACM
Alarm Circuit
Module**

x1

Required



**SCM-PM
Printer
Module**

x1



**SCM-NM
Network
Module**

x1

3 Ports will still be available
Allowing additional system requirements



**SCM-LAN
TCP/IP
Module**



**SCM-RM
Relay
Module**



**SCM-MIM
Multi Input
Module**

System Configuration Options

1-24 Zones with printer and a sounder circuit module

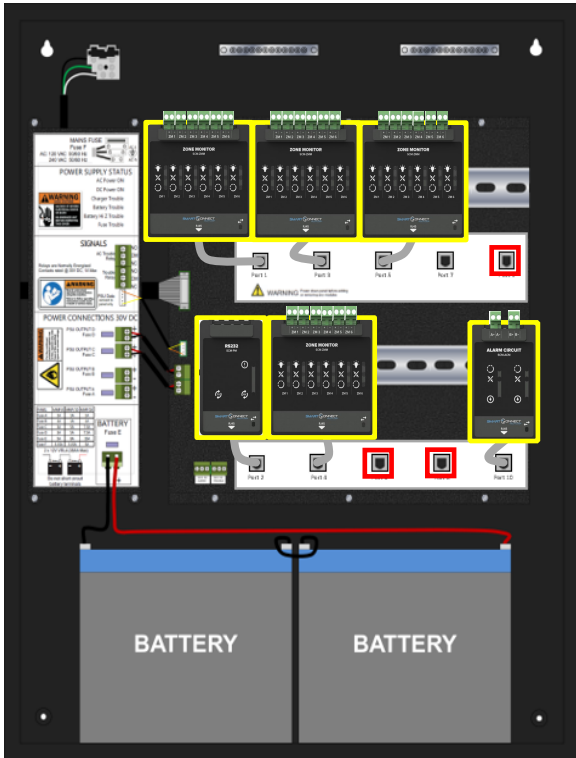

Required Modules for configuration
 Available Ports to add modules

Required



SCM-ZMM
Zone Monitor
Module

x4

Required



SCM-ACM
Alarm Circuit
Module

x1

Required



SCM-PM
Printer
Module

x1

3 Ports will still be available
Allowing additional system requirements



SCM-NM
Network
Module



SCM-LAN
TCP/IP
Module



SCM-RM
Relay
Module



SCM-MIM
Multi Input
Module

1-24 Zones with printer, sounder circuit module and networked

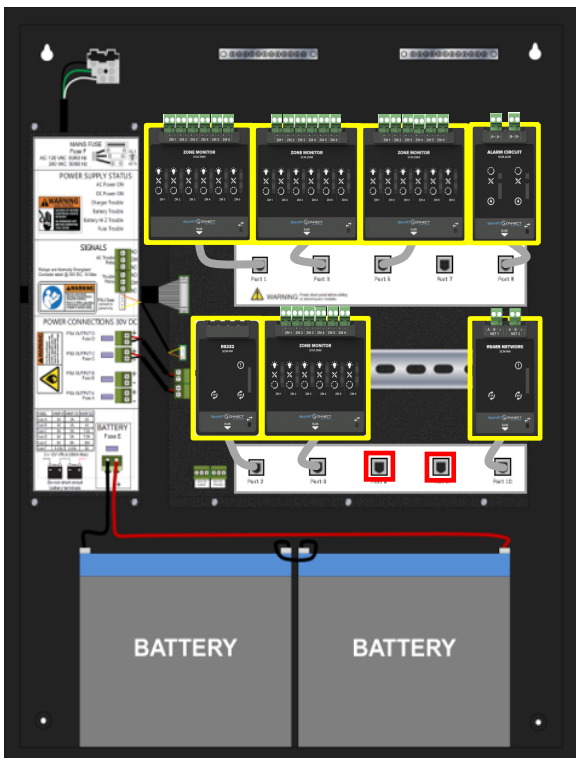

Required Modules for configuration
 Available Ports to add modules

Required



SCM-ZMM
Zone Monitor
Module

x4

Required



SCM-ACM
Alarm Circuit
Module

x1

Required



SCM-PM
Printer
Module

x1

Required



SCM-NM
Network
Module

x1

2 Ports will still be available
Allowing additional system requirements



SCM-LAN
TCP/IP
Module



SCM-RM
Relay
Module



SCM-MIM
Multi Input
Module

System Configuration Options

1-30 Zones with printer and a sounder circuit module

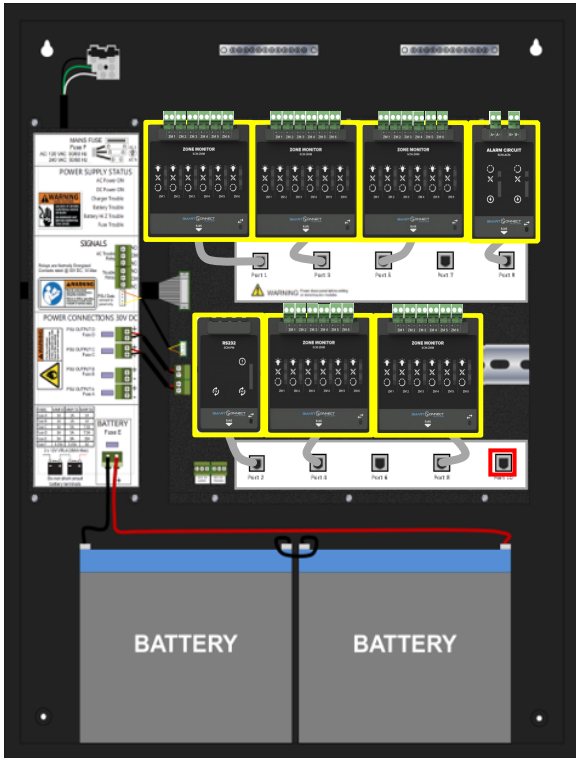

Required Modules for configuration
 Available Ports to add modules

Required



**SCM-ZMM
Zone Monitor
Module**

x5

Required



**SCM-ACM
Alarm Circuit
Module**

x1

Required



**SCM-PM
Printer
Module**

x1

1 Port will still be available
 Allowing additional system requirements

**SCM-NM
Network
Module**

**SCM-LAN
TCP/IP
Module**

**SCM-RM
Relay
Module**

**SCM-MIM
Multi Input
Module**

1-30 Zones with printer, a sounder circuit module and networked

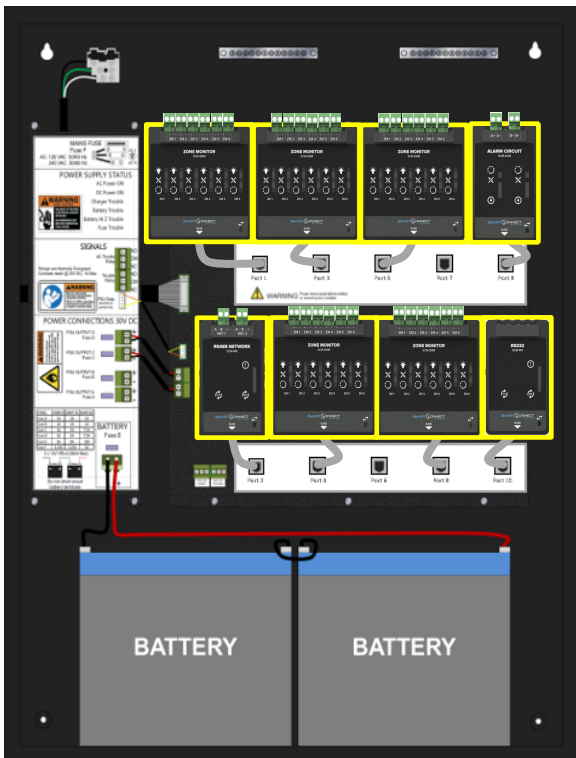

Required Modules for configuration
 Available Ports to add modules

Required



**SCM-ZMM
Zone Monitor
Module**

x5

Required



**SCM-ACM
Alarm Circuit
Module**

x1

Required



**SCM-PM
Printer
Module**

x1

Required



**SCM-NM
Network
Module**

x1

No Ports available

**SCM-LAN
TCP/IP
Module**

**SCM-RM
Relay
Module**

**SCM-MIM
Multi Input
Module**