

Trace*Line*[™]

**Self-Adaptive Compensation Line Type Heat
Detector**

Manual No. 089208

Issue 2

Zeta Alarm System.

PROPRIETARY RIGHTS NOTICE

This document and the information that it contains are the property of Zeta Alarm System. Rights to duplicate or otherwise copy this document and rights to disclose the document and the information that it contains to others and the right to use the information contained therein may be acquired only by written permission signed by a duly authorized officer of Zeta Alarm System.

AMENDMENT INCORPORATION RECORD		
Amendment Number	Brief Description of Content	Name of Person Incorporating Amendment
1		
2		
3		
4		
5		
6		
7		
8		
9		

CAUTION

ANTISTATIC PRECAUTIONS

WHEN HANDLING ANY ELECTRONIC COMPONENTS OR CIRCUIT BOARDS, ANTISTATIC PRECAUTIONS MUST BE CARRIED OUT. FAILURE TO DO SO MAY RESULT IN COMPONENT DAMAGE.

Static discharge can be reduced by adhering to the following guidelines.

1. Always use conductive or anti-static containers for transportation and storage if returning any item.
2. Wear an earthed wrist strap while handling devices and ensure a good earth is maintained throughout.
3. Never subject a static sensitive device to sliding movement over an unearthed surface and avoid any direct contact with the pins or connections.
4. Avoid placing sensitive devices onto plastic or vinyl surfaces.
5. Minimize the handling of sensitive devices and PCBs.

Table of Contents

1	General	1
1.1	Introduction.....	1
1.2	Application Specification	1
1.3	Terminology	2
1.4	Comparison	3
1.5	Features and Benefits.....	4
2	Line Type Heat Detecting Cable	5
2.1	General.....	5
2.2	Principle.....	5
2.3	Technical Specifications	6
3	Monitor and Control Unit	8
3.1	General.....	8
3.2	Normal Type MCU	8
3.3	Location Type MCU	8
3.4	Technical Specifications	9
4	Setting Parameters and Commissioning the MCU	11
4.1	Parameter Setting Method	11
4.2	How To Set Parameters	11
4.3	Parameter Configuration and Commissioning Software	12
5	Applications	13
5.1	Typical Applications	13
5.2	Cable Trays and Racks.....	15
5.3	Road and Rail Tunnel	17
5.4	Conveyor Belt	19
5.5	Floating Roof Fuel Storage Tanks	20
5.6	Rack Storage and Freezer Warehouse	22
5.7	Petrochemical Product Pumps.....	23
5.8	Boiler and Furnace Burner Areas	24
5.9	Power Distribution Equipment.....	24
5.10	Flammable Oil Area and Transformer	25
5.11	Escalators.....	25

6 Design Considerations27

- 6.1 Sensor Cable Selection 27
- 6.2 MCU Selection..... 28
- 6.3 Application Considerations 29
- 6.4 Intrinsically Safe Applications of LHDC 29

7 MCU Installation30

- 7.1 Description..... 30
- 7.2 Installation Dimensions 30
- 7.3 Connections..... 31
- 7.4 Wiring Details..... 32
- 7.5 Function of Control 33

8 TraceLine™ Installation35

- 8.1 Installation Overview..... 35
- 8.2 Hazardous Areas 35
- 8.3 Cable Fixings 36
- 8.4 Junction Box and EOL box..... 38
- 8.5 Cable Stripping 40
- 8.6 Cable End Termination..... 40
- 8.7 Cable Jointing 41

9 Commissioning42

- 9.1 Preparatory 42
- 9.2 Setting and Debugging 42
- 9.3 Procedure 42

10 Maintenance44

- 10.1 Log 44
- 10.2 Routine Maintenance 44
- 10.3 Fault Finding Procedures 44

11 Calibration for Location Type TraceLine™46

12 LDS V2.0 Setting and Debugging Software48

- 12.1 Introduction..... 48
- 12.2 Operating Procedure (Windows® Version) 48
- 12.3 FAQ (Windows® Version) 53

13 Ordering Information54

1 General

1.1 Introduction

As a highly effective and reliable fire detection method, Line Type Heat Detector (LHD) has been employed in many applications to detect industrial, commercial or other special fire or overheating risks.

While several types of temperature sensing technologies, such as analogue LHD, digital LHD, fiber-optics and pressurized pneumatic tubing are available, the analogue LHD products are the most widely used today. Additionally, TraceLine™ LHD has some very significant improvements, such as a self-adaptive compensation function and location function, to ensure more effective usage.

TraceLine™ can provide general space protection as well as detection at the point of risk and is especially suitable for confined areas or harsh environments in which other types detection methods would not be viable. TraceLine™ sensor cable and associated MCU allows full integration with fire alarm control panels and extinguishing systems.

In view of these factors, the purpose of this manual is to ensure that coverage of the area to be protected is in accordance with accepted fire protection principles and to provide uniform installation guidance. We would be pleased to advise on the suitability of TraceLine™ for any other application.

1.2 Application Specification

1.2.1 Design

TraceLine™ design, installation and maintenance must be in accordance with the manufacturer's application and installation manuals, according to the application being considered. As a variance exists on most applications, it is recommended that the manufacturer's guidance is sought for each project. Consideration shall be made of the following:

- nature of risk
- maximum ambient temperature
- characteristics of the ambient conditions
- alarm or fire zones
- risk of mechanical damage
- location of display and controls
- requirement for Zener Barriers
- interfaces to other fire alarm or extinguishing systems

A range of LHD to cover the specification temperature range from -40 °C to +140 °C is available.

Analogue Line Type Heat Detecting Cable (LHDC) (rate of rise and point of risk) sheathings are available for a wide range of applications.

- Standard coating
- Polytetrafluoroethylene coating
- Standard coating with bronze braiding

- Polytetrafluoroethylene coating with bronze braiding
- Any other special coverings

For operation in the range -40 °C to +120 °C, 5-core sensor cable provides monitoring for open and short circuit. Alarm settings can be matched to the environment.

Cable recoverability provides continuous protection.

The Monitor & Control Unit (MCU) interfaces to a range of control and output units.

TraceLine™ is capable of operating with interposing cable.

TraceLine™ is capable of operating within zone 0 applications via suitable Zener Barriers.

1.2.2 Monitor & Control Unit

The Monitor & Control Unit (MCU) for the sensor cable provide fire and fault conditions, with setting of alarm conditions to match temperature condition for the environment.

The MCU has the ability to be connected to a standard detection zone of a fire alarm control panel.

1.2.3 Installation

The installation method should be as recommended in this installation manual and be in accordance with regulatory, site and environmental requirements.

Clips and fittings recommended in this installation manual should be used and matched to site and environmental conditions.

1.2.4 Commissioning

The sensor cable is capable of controlled tests via a heat oven. This should only be applied to the sensor cable within a safe area.

1.2.5 Approvals

- UL listed
- CE approval
- Regional approval

1.3 Terminology

Line Type Heat Detector (LHD): detector which responds to heat sensed in the vicinity of a continuous line. A line type heat detector may consist of a monitor control unit, a sensing element and accessory elements (junction box, EOL box, clip, etc.).

Line Type Heat Detecting Cable (LHDC): sensing element of a Line Type Heat Detector.

Monitor Control Unit (MCU): connected to sensor cable and is used to measure, compute, make alarm decision and output alarm information.

EOL: end-of-line device for the MCU.

1.4 Comparison

COMPARISON CHART	Zeta Analogue LHD	Zeta Digital LHD	Digital LHDC	Other Analogue	Line Thermo Couple	Pressure Tube
Self adapt and compensate to a variety of environments	✓	✗	✗	✗	✗	✗
Self adapt length variety of LHDC	✓	✗	✗	✗	✗	✗
Locate of fire source	✓	✓	✓	✗	✗	✗
Display equivalent temperature of LHDC	✓	✗	✗	✗	✓	✗
Rate-of-rise heat alarm	✓	✗	✗	✗	✓	✓
Adjustable alarm level	✓	✗	✗	✓	✓	✗
Adjustable pre-alarm	✓	✗	✗	✗	✓	✗
Resetable / Recoverable	✓	✓	✗	✓	✓	✗
Open-circuit fault monitoring	✓	✓	✓	✓	✓	N/A
Short-circuit fault monitoring	✓	✓	Alarm	✓	✗	N/A
Easily installed	✓	✓	✓	✓	✗	✗
Easily jointed	✓	✓	✓	✓	✗	✗

Notes

- 1 Except for Zeta Digital LHD, other types Digital LHDC are manufactured by our competitors.
- 2 Zeta and our competitors can provide location of alarm position, however Zeta is better for the following reasons:
 - a) Zeta products are Recoverable LHD. Competitors product is short-circuit type LHD that can not recover when the environmental temperature exceeds the alarm temperature.
 - b) Zeta products can be set any alarm temperature (pre-alarm and alarm) between suitable range of 68 °C to 140 °C, and can provide rate-of-rise temperature alarm.
 - c) Zeta products can detect overheating or fire location without a short circuit. Competitors' products detect the fire location only when the LHDC is short-circuit, then can not be re-used.
- 3 The Zeta Locating type LHD is a unique analogue recoverable line type heat detector, which can locate overheating points or the fire position.

1.5 Features and Benefits

- Self-adaptive and compensation for variation of environmental temperature and humidity.
- Location and display of the linear distance in metres of overheating or alarm point.
- Employed with the corresponding types LHDC to form fixed temperature, rate-of-rise or fixed temperature and rate-of-rise Line Type Heat Detector.
- Two levels of alarm (pre-alarm and alarm) with different adjustable alarm temperature for fixed temperature detector, or rate-of-rise alarm and fixed-temperature alarm for FT/RoR detector.
- All system parameters are set by easy-to-use software.
- Equivalent temperature display.
- In-built RS 485 communication mode to allow all alarm parameters (Alarm type, Location) to be displayed on a management computer.
- Rugged construction for use in harsh environments.
- Compatible with many existing zone monitors / control equipments.
- Recoverable and resettable (testable) operation.
- UL Approved and Listed.

2 Line Type Heat Detecting Cable

2.1 General

The TraceLine™ Line Type Heat Detector is designed to provide early detection of fire conditions and overheating in circumstances where other forms of detection would not be viable, either due to inability to sustain the environmental requirements or through prohibitive costs.

Extensive single zonal lengths of the Line Type Heat Detecting Cable (LHDC) may be installed with the ability to trigger alarms for 'hot spots' occurring on very small sections of the overall cable. Location type LHDC can be used to measure the linear distance from MCU to hot spots.

The LHDC may be employed in a wide variety of applications but is particularly suited where there are harsh environmental conditions, physical or hazardous maintenance access constraints in the protected area, or a requirement to cost effectively install detection in close proximity to the risk(s).

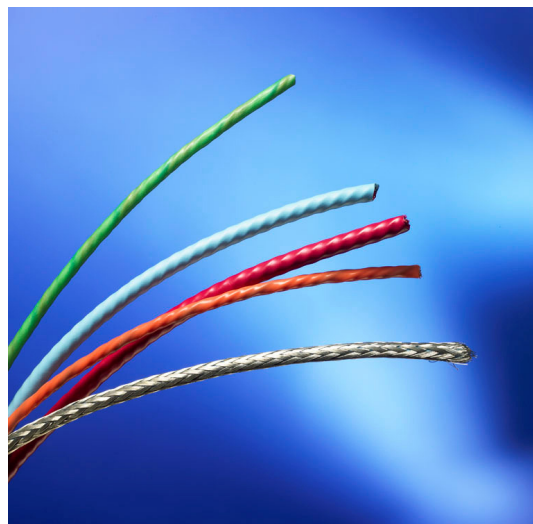

2.2 Principle

The Line Type Heat Detector consists of a 4-core cable and a fortified Nylon thread. Two of the four colour-coded conductors are insulated with a Negative Temperature Coefficient material.

The other two conductors have normal PVC insulation. The cores are twisted together and protected by an outer sheath of high temperature rating, flame-retardant PVC insulation (see Figure 2.1). Two special metal material conductors are used for supervision and fire location wire in location type LHDC.

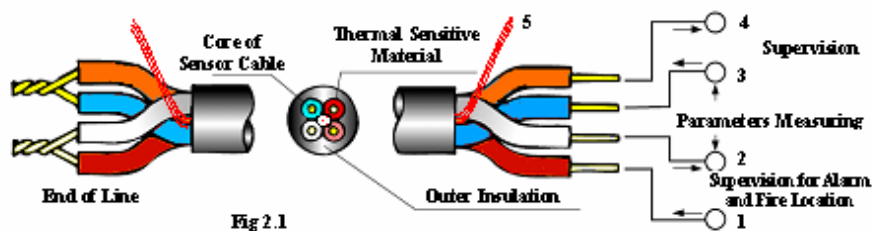

The structure of the Locating Type Analogue LHD is similar to the Self-Adaptive Compensation LHD, with the following differences.

- The thermal sensitive material and conductor material are different.
- Specialized Monitor Control Unit can calculate and display overheating point or fire position along LHDC.

The primary mechanism of heat (fire) detection is the change in the resistance of the dielectric, monitored between the two conductors coated with NTC. This NTC characteristic is a logarithmic function and thus the resistance at normal ambient temperatures is much greater than at abnormal alarm temperatures.

Other parameters exhibited by the cable include capacitance effects. The cable must be

employed in conjunction with the correct type of monitoring unit.

When correctly configured, considerable lengths of the sensor cable may be installed, whilst LHD maintain the ability to trigger alarms for 'Hot Spots' on small sections of the detector cable.

Additionally, when the resistance becomes lower, the MCU locator can detect hot points and give a linear distance location from MCU to the hot point.

Termination of the cable is achieved with each temperature sensitive core connected to one of the standard cables. This provides for open-circuit or short-circuit protection throughout the cable length.

2.3 Technical Specifications

Fifteen types sensor cable and five types MCU are available in different applications, as showed in Tables 2.1 and 2.2.

Table 2.1 – Monitor and Control Units

	Self-adaptive Compensation Line Type Heat Detector		
	Fixed Temperature Detector	Rate-of-Rise Heat Detector	Fixed Temperature and Rate-of-Rise Heat Detector
Sensitive Cable	NBC800/F	NBC800/R	NBC800/FR
Zone Monitoring Control Unit	NBM800/F	NBM800/R	NBM800/FR
Main Parameter	Alarm Temperature Range for 1 m: 68 °C ~ 140 °C	Rate-of-Rise Temperature Range: 8.3 °C/min ~ 30 °C/min	Alarm Temperature Range for 1 m: 68 °C ~ 140 °C. Rate-of-Rise Temperature Range: 8.3 °C/min ~ 30 °C/min
Note: if detector is Locating Type Products, "L" should be added to the model. For example, NBC800/L /F and NBM800/L /F mean Locating type fixed temperature detector.			

Table 2.2 – Sensor cable

	NBC800 Series Line Type Heat Detecting Cable (LHDC)		
	High Temperature PVC	Polytetrafluoroethylene	Bronze Braid for Explosion and EM-Proof
Part Number	NBC800/XX	NBC800/XX/NC	NBC800/XX/BB
Normal Packed Length	400 m, 600 m or 800 m		
External Diameter (nominal)	2.4 mm	2.1 mm	2.55 mm
Minimum Tensile Strength	120 N	120 N	500 N
Ambient Temperature	-20 °C ~ 100 °C	-40 °C ~ 120 °C	-40 °C ~ 120 °C
Conductor	Copper for normal type LHDC. Special alloy material for Location type LHDC		
Insulation	Cores 2 and 3: Specially doped polymer. Cores 1 and 4: PVC. Other cores (if any): Special material		
Core Color	1= Red; 2= White; 3= Blue; 4= Orange; 5 or 6 (if any)= White, Yellow or Green		
Service Life	Up to 100 °C: 30 years		
Voltage Proof	10 kV between outer sheath and a conductor		
Maximum Distance for Laying	9 m (Refer to UL521 and FM3210)		
Notes:	1. XX includes F, R or FR symbol, meaning Fixed Temperature, Rate-of-Rise Temperature or Fixed Temperature and Rate-of-Rise heat detector. 2. If the detector is the Locating Type products, add “/L” the model designation.		

3 Monitor and Control Unit

3.1 General

The Monitor and Control Unit (MCU) is an exclusive feature designed to monitor a length of Analogue Linear Heat Detecting Cable (LHDC) for both overheating or fire condition and fault status. Additionally, it is more important to locate an overheated point or fire spot along the LHDC.

The Location type MCU provides a 4 digit LED display show the linear distance in meters from the start of MCU to the alarm point.

The MCU can be used for Fixed Temperature (FT) alarm (Models NBM800/F or NBM800/L/F), Rate-of-Rise Temperature (RoR) alarm (Model NBM800/R), and Fixed Temperature and Rate-of-Rise Temperature (FT-RoR) alarm (Models NBM800/FR or NBM800/L/FR).

For fixed temperature models NBM800/F or NBM800/L/F, two adjustable temperature levels of alarm are provided. The first level alarm is employed as “Pre-alarm” and the second level alarm is employed as “Fire alarm”.

For rate-of-rise model NBM800/R, only “Fire alarm” is used.

For fixed temperature and rate-of-rise models NBM800/FR or NBM800/L/FR, the first level alarm is a rate-of-rise alarm and the second level alarm is a fixed temperature alarm.

The system may be used in a wide variety of applications but is particularly suited where there is a harsh environmental condition, a physical or hazardous maintenance access constraint to the protected area, and/or a requirement to cost effectively install detection in close proximity to the risk(s).



3.2 Normal Type MCU

The Self-adaptive Compensation Analogue LHD can self-adapt to a variety of environments, including temperature and humidity. The compensation enables the exact alarm to be provided, without reducing the sensitivity of the detector or increasing the likelihood of unwanted alarms. Thus, it is different from other analogue LHD, where the alarm temperature of a 1 m unit length sensor cable is not necessarily adjusted to compensate for the changes in the environmental ambient temperature.

3.3 Location Type MCU

Using patented measurement technology, the MCU automatically determines the linear distance from the start of MCU to the overheated or fire point, and displays the distance on LED display.

Figure 3.1 shows a typical configuration.

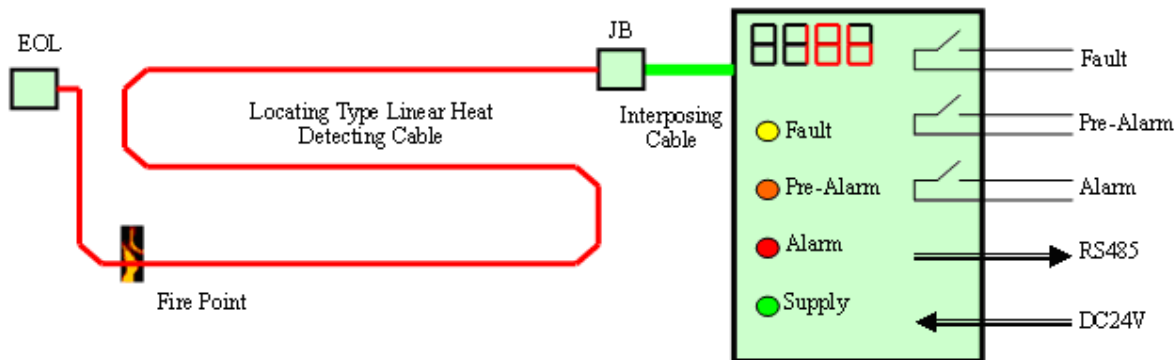

Figure 3.1 – Sensor cable and MCU configuration

When the LHD with the Location Function is used in different applications, Specialized Management Software on computer can be used to locate the real position according to the linear distance provided by the MCU.

3.4 Technical Specifications

Display:

Four digital LED: 0 to 1999

Unit accuracy: +/-0.5% digit

Location tolerance above 120 °C heat box for 1 m length heated: +/-5%L (where L is the total length of a loop LHDC, ≥50m)

Sensor cable compatibility:

Should be connected with the corresponding type LHDC. For example, /L/F type MCUs must be matched with /L/F type LHDC.

Monitoring Supply:

Voltage: 24 Vdc ± 20%

Current: Quiescent < 65 mA; Fault, Alarm < 60 mA

Fire A1 or A2 Alarm < 85 mA; Fire A1 & A2 Alarm < 100 mA

Operating Temperature Range:

-20 °C to +70 °C (+80 °C on special request)

LHDC Input:

Two levels of alarm: F1 and F2; Fault monitored for open-circuit and short-circuit

Relay Contacts Output:

1 A @ 24 VDC

Fire Alarm F2: Single pole, normally closed

Fire Alarm F1: Single pole, normally closed

Fault: Single pole, normally open

EMC:

Meets the requirements of EN 61000-6-3 and EN 50130 standards.

Enclosure:

Polycarbonate or ABS to IP66~67

(200H x 138W x 70D) mm

Color grey

Weight 0.40 kg

DISPLAY and OPERATE:

The front panel of MCU and the function of each control and indicator is described below.

Temperature/Fire Position/Heated Length Display

For Normal type MCU, the display shows LHD type. For Location type MCU, the display also shows fire (or overheating) position.

Fire A2 LED

Continuous operation indicates alarm for fixed temperature (overheating of fire condition).

Fire A1 LED

Continuous operation indicates pre-alarm for fixed temperature or alarm for rate-of-rise temperature (overheating of fire condition).

LHDC Fault LED

A yellow LED indicates a sensor cable fault within the TraceLine™ system, either open-circuit or short-circuit.

LHD Run/Fault LED

A green LED indicates normal system operation. A yellow LED indicates a system fault, either low power PCB fault.

Test: Fire and Fault Switch

A switch is provided to test for a pre-alarm for fire alarm indication. To test for a pre-alarm and fire alarm indication, press the fire test button for up to 2 seconds and ensure that the FIRE A1 LED is lit. After a 2 second interval, press the fire test button again for 5 seconds and ensure the FIRE A2 LED is lit.

A switch is provided to test the fault indication. To test for a fault indication, press the fault test button for up to 2 seconds and ensure that the FAULT LED is lit.

A switch is provided to reset the MCU. To reset the MCU, press "Reset Button" or power down the MCU.

4 Setting Parameters and Commissioning the MCU

Generally, the calibration switch setting should be determined from the maximum ambient temperature, the alarm temperature and the total length of sensor cable. However the NBM800 Series MCU can adapt to a variety of surrounding temperatures to give exact alarm. So if a cable length of less than 200 m for fixed temperature and rate-of-rise heat detector (FT-RoR Type) or fixed temperature heat detector (FT Type) is used, only the alarm temperature for 1 m (or 0.91 m) is required to be set for the Zone Monitor Unit can give exact alarm.

4.1 Parameter Setting Method

The parameters can be set through computer or PDA using special applied software, as shown in Figure 4.1. The installer can set the following parameters:

- Total Length of one Zone Loop
- Temperature of Pre-Alarm and Alarm
- Maximum environmental temperature
- Network physical address.

Sensitivity, precision and function are factory pre-set parameters and not adjustable by the installer.

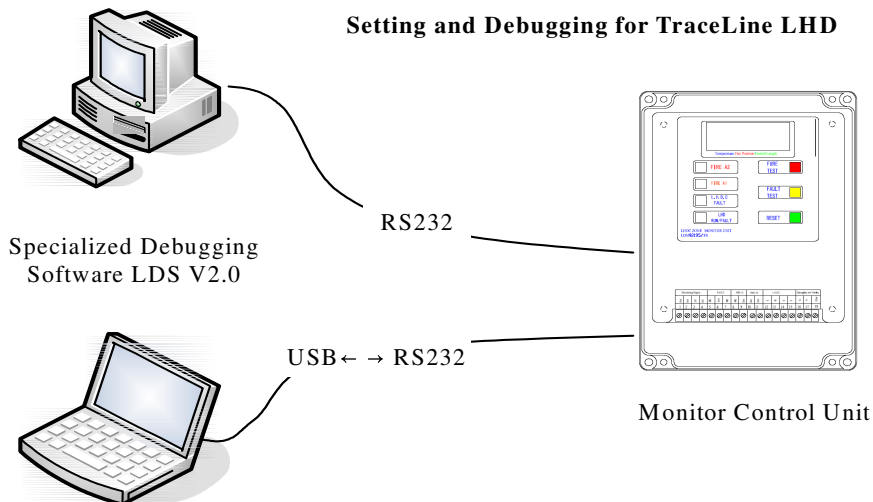

Figure 4.1 – Parameter setting method

4.2 How To Set Parameters

The following parameters are recommended:

Indoor use

The alarm temperature for 1 m sensor cable should normally be at least 45 °C above the maximum environmental temperature. For example, when the maximum environmental temperature is 45 °C, then the pre-alarm and alarm temperature should be equal to or more than 90 °C. For a stable environment, 30 °C can be used.

Outdoor use

The alarm temperature for 1 m sensor cable should be at least 60 °C above the maximum surface temperature of protected objects, if LHDC is installed on the surface of protected objects. If LHDC is installed at more than 50 mm above the surface, the alarm temperature should be at least 50 °C above the maximum surface temperature of protected objects.

The installer can set the parameters arbitrarily if the parameters accord with the above method. The MCU can self-adapt the surroundings environmental temperature and humidity.

4.3 Parameter Configuration and Commissioning Software

LDS 2.0 configuration and commissioning software performs parameters setting and testing of the detector. The software comes in both Windows® and Windows CE® versions. The main features for both versions are identical. Connect with the detector through the RS 232 serial port of the computer.

The software is user friendly and does not create any registry in the computer operating system. Simply copying it to any disk will allow it to run.

Compatible Windows® versions are Windows 2000®, Windows 2000 Server®, Windows XP®, and Windows 2003 Server®. Windows 98® is not supported.

The Windows CE® version is compatible with Pocket PC 2003 or higher operating system.

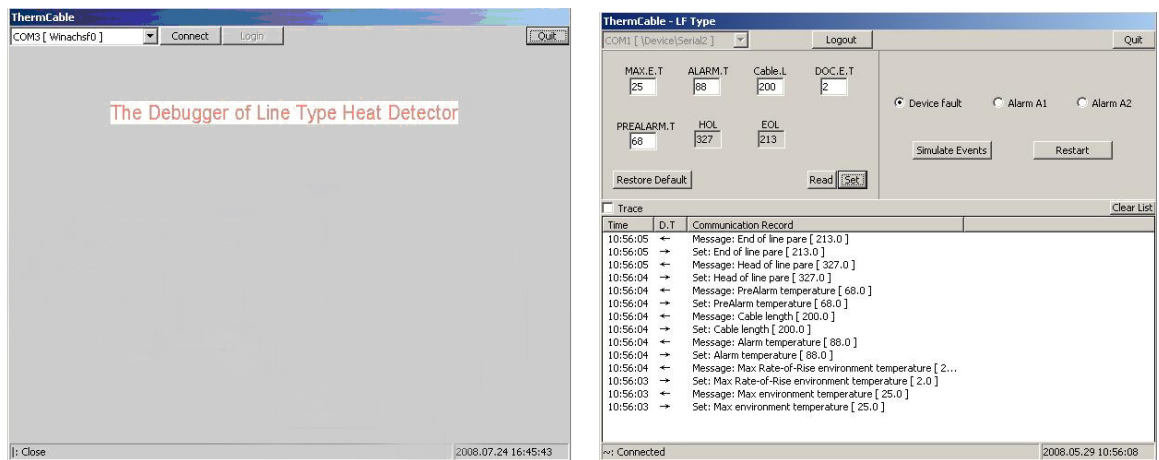

Full instructions on the use of the software is given in Section 12.

5 Applications

5.1 Typical Applications

Electricity generating plants:	<ul style="list-style-type: none"> Cable trays and racks (power, control or communication cables) Cable Tunnel, Cable Room Boiler front - burner protection Conveyors - bearing overheat Transformers Control room and computer suites - floor voids Cooling towers Oil Tank and Oil Pipeline Alternator pits
Steel works:	<ul style="list-style-type: none"> Cable trays (cable tunnel, cable room) Underground hydraulic station Underground lubrication oil station Transformer Electrical equipments Painting room Control room and computer suites - floor voids Storage racks Covered conveyor protection
Wire manufacturers:	<ul style="list-style-type: none"> Control cubicle protection
Ships and shipyards:	<ul style="list-style-type: none"> Construction - steelwork/wooden supports Ducting and pipework Control cubicles Radar installations Missile storage Marine: "Cocooned" ships Engine bay protection - leisure craft
Petro-chemical (on-shore):	<ul style="list-style-type: none"> Ethylene "sphere" storage Storage tanks - floating roofs Cable trays and road tanker protection Chemical equipment areas
Petro-chemical (off-shore):	<ul style="list-style-type: none"> Well heads and cable trays
Nuclear power plant:	<ul style="list-style-type: none"> Cable tray Transformer Electrical equipments Oil storage tank and pipeline Laboratory test equipment - PCB component overheat
Gas board:	<ul style="list-style-type: none"> Power units and pumps
Supermarkets:	<ul style="list-style-type: none"> Cold storage wiring Escalator

Zeta Alarm System.

Self-Adaptive Compensation Line Type Heat Detector

Hospitals:	Service ducts
Rubber grinding plant:	Dust extraction duct
Aluminium works:	Cable trays, mixers and conveyors
Computer suites:	Ceiling, floor voids, control cubicles and power supplies (overheats)
Grain driers and storage:	Silos and driers
Water authorities:	Cable tunnel and switchgear
Resin plant:	Storage tank
Automatic pumping stations:	Transformer bay and cable ducts
Coal mills:	Pipework carrying coal dust to boilers
Local government authorities:	Road tunnels and refuse tips
Hotel, Casino, Dance halls:	Ceiling protection and decorative ornament protection (Artificial trees etc) EscalatorsLifts/elevator shaftsDucts ventilation/extraction/cableFalse floors/ceilings Kitchens cook hoodsElectrical cupboardsStorage roomsRefuse areasLaundry rooms
Cottages:	Thatched roofs
Motor parts manufacturers:	Gas fired drying conveyor oven Paint storage
Chemical plants:	Reactor vessels
Ducting manufacturers:	Extraction and ventilation systems
Plastic coating process plant:	"Dip" tank protection
Timber yards:	Bearings - machine shop
Government departments:	High rack storage
Airports:	Cable tray Aircraft hangars Passenger walkways Duty free goods storage Baggage conveyors Escalators (bearing overheats and dust collecting trays) Service subways
Cold storage plants:	Warehouse and power house - water boxes
Forklift truck (overnight charging):	Battery box overheat protection

Heating units:	Oil pipe temperature monitoring
Power plant:	Conveyors
Cereal plant:	Freezing chamber - high rack food storage
Sugar refinery:	Sugar conveyors
Electronic component manufacturers:	Storage racks
Rail authorities:	Buildings: Underground railway tunnels, stations and escalators, cable tray, transformer Rolling stock: Flexible couplings and exhaust manifolds
Industrial kitchens:	Canopy protection
Postal service:	Sorting conveyors Multi-storage car parks

5.2 Cable Trays and Racks

Cable trays and racks are located in factories, tunnels and large buildings, and are usually densely filled with a variety of cables such as electric power, control and communications. They are the central nervous system of a factory, city, or a large building. The typical characteristics of the cable tunnels are:



- Link the power, control, and communication systems, between building structures, so once a fire occurs, the impact and damage to a business due to an inadequate fire detection system can be crippling.
- Fire caused by burning cables spreads quickly and results in considerable amounts of poisonous gas and high temperatures, making it difficult to control the spread of the fire and to perform life safety rescues.
- Typical fire detection systems, such as point detection do not function well in these environments because of high humidity and strong electromagnetic interference sources.

TraceLine™ is suitable for use in cable tunnels. When compared to other detection methods in the same environment, environmental compensation of TraceLine™ can ensure its high sensitivity and minimize false alarms. The rate-of-rise temperature alarm and multistage alarm functionality of TraceLine™ is an effective combination for early fire detection.

The installation of TraceLine™ sensing cable can be the sine-wave contact type or line hanging type, depending on the fire protection design requirements. The sine-wave makes direct contact with the surface of a cable, increasing sensitivity and faster alarm detection. The line hanging type allows for easier cable access and maintenance. For details please refer to Figure 5.1.

Typically, cable tunnels use multi-level cable trays for cable support and installation. Line type heat detecting cable (LHDC) may be economically applied to monitor above each level of wiring trays and below the bottom level, to protect against debris fires from accumulated dust.

The design of the detection zone may be decided by the following:

Physical barriers, Fire Zone or Fire Breaks

Access ways etc., for fire fighting personnel

Zoning of Deluge System or other extinguishants

A “zone” is a length of Line Type Heat Detecting Cable connected to a Monitor and Control Unit (MCU) with the MCU being housed in a protected location. The length of detecting cable in any zone is determined by the “Characteristics of Line Type Heat Detecting Cable Systems”.

The MCU provides remote monitoring signals, which can be monitored at a central monitoring location.

By utilizing NBM800 series MCU or Locator, systems can be provided with the following features:

- Fixed temperature or rate-of-rise and fixed temperature alarm
- Location of overheat and alarm point
- Adjustment of pre-alarm and alarm level
- Fire alarm and actuation only in a true fire condition
- fault of the detection cable.

When installed as SINE, the length of sensor cable is calculated using the following formula:

LHDC Length (L) = Length of Cable Tray x k

Coefficient, k, is chosen according to the Table 5.1.

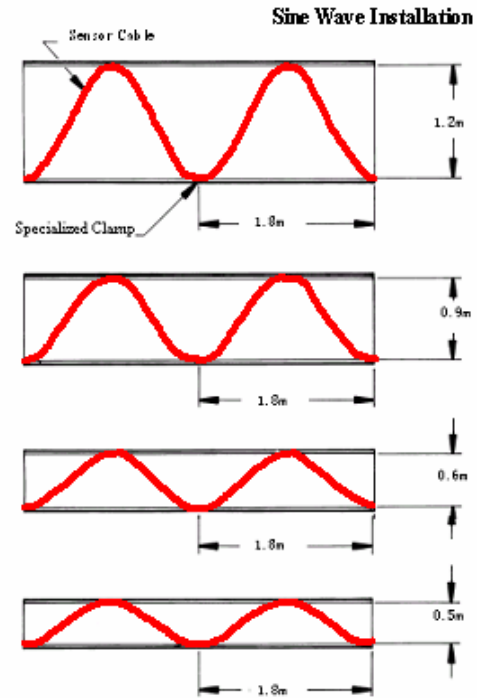
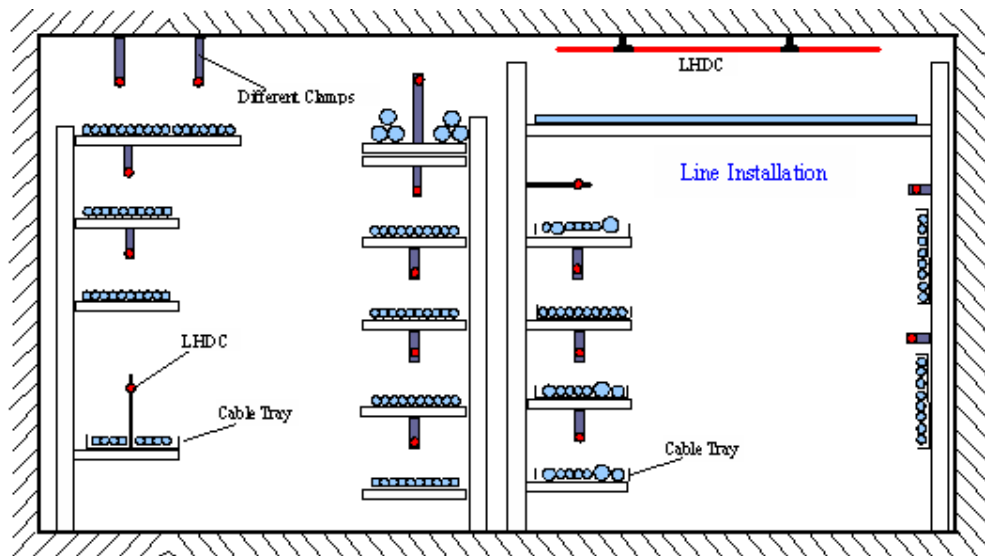

Figure 5.1 – Sine installation

Table 5.1 – Times coefficient, k, for SINE layout

Item	Width of Tray (m)	Coefficient (k)
1	1.2	1.8
2	0.9	1.6
3	0.6	1.3
4	0.5	1.2
5	0.4	1.1



5.3 Road and Rail Tunnel

Road and rail tunnels have following fire protection issues:

- Length of tunnels and limited exit and entry points make early detection a critical requirement.
- Environmental conditions are harsh inside a tunnel. Environmental factors such as high humidity, high oil and gas fumes, dust, electromagnetic interference, etc. must be considered in your fire protection plan.
- The temperature in the tunnel changes in accordance with outside weather and vehicle flow. These changing environmental conditions will usually cause false alarms for a point detection system without an environmental compensation function.



When used in a tunnel, the fire detection systems must overcome three problems:

- Detection of the fire in its early stage of development.
- Immunity to false alarms.
- Environmental compensation function to cope with the fast changes of temperature and humidity.

TraceLine™ meets the above requirements. Its rate-of-rise temperature alarm function can detect the fire in its early stage. The environmental compensation function of the sensing cable and the construction of the MCU resists the effects of adverse environmental conditions.

The design of the detection zone may be decided by the following:

Physical barriers, Fire Zone or Fire Breaks

Access ways etc., for fire fighting personnel

Zoning of Deluge System or other extinguishants

For each “zone” a length of LHD cable is connected to the MCU, the latter being housed in a protected location.

The length of detecting cable in any zone is determined by the “Characteristics of Line Type Heat Detecting Cable Systems”. When confronted with long distances between the detection zone and the MCU, a special low capacitance extension cable is available.

By using RS 485 communication bus or input module of fire alarm system, MCU signals are monitored at a central location.

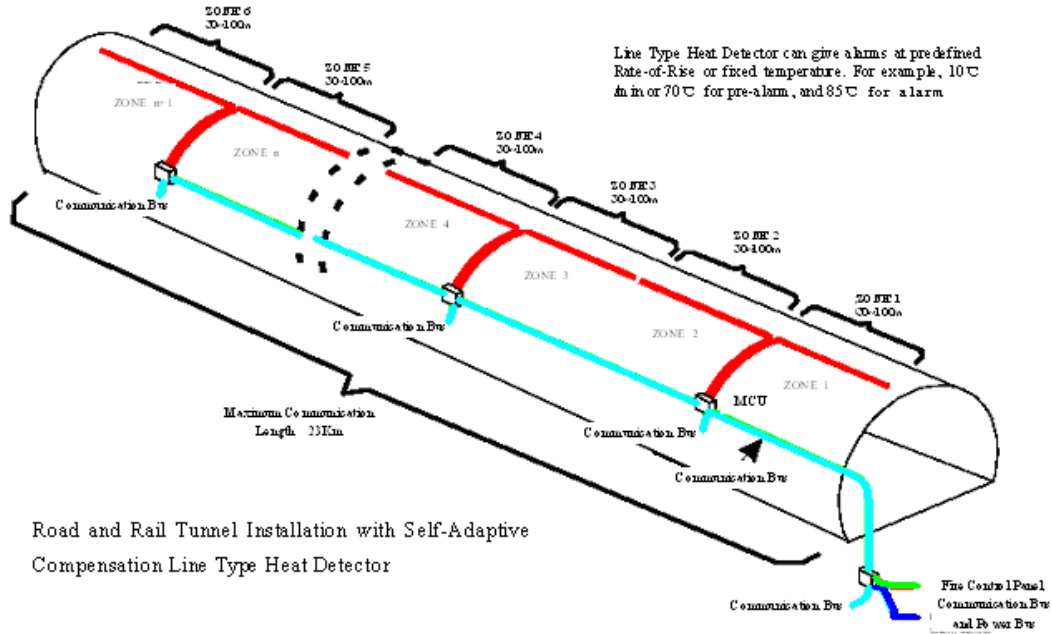

Road and Rail Tunnel Installation with Self-Adaptive Compensation Line Type Heat Detector

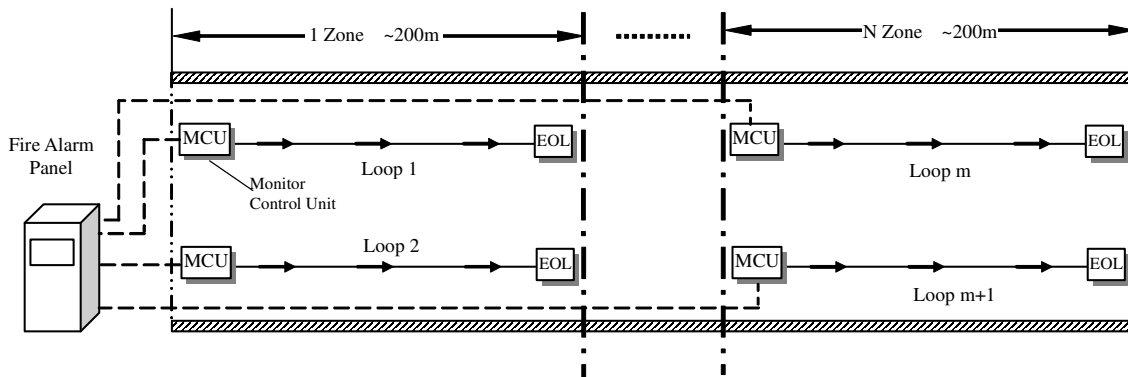

Fig 5.4 Line Laying Mode for Three Roadway Tunnel

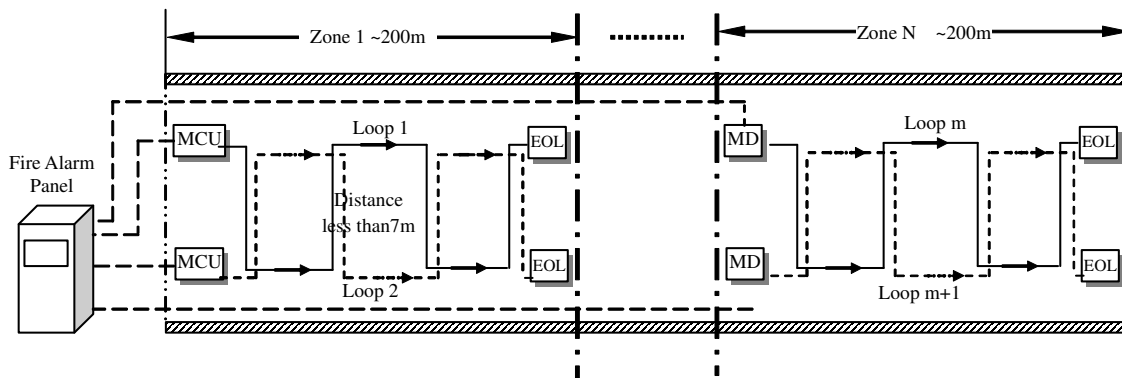

Fig 5.5 Square Wave Laying Mode

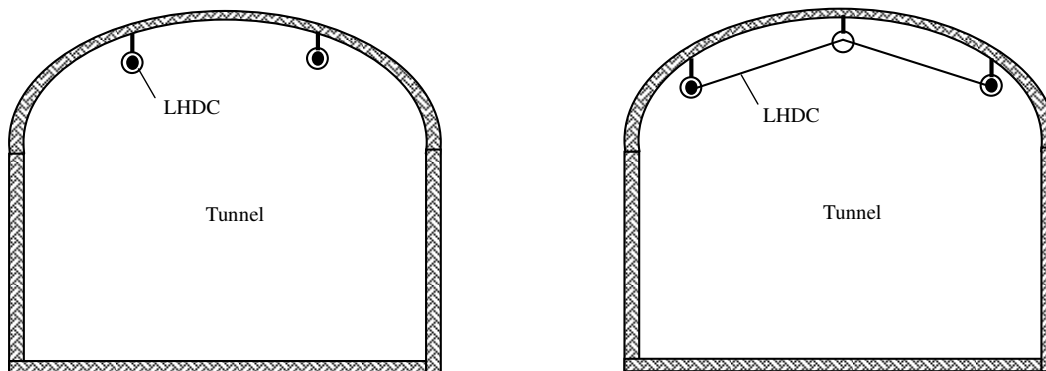

Figure 5.6 – Road tunnel sensing cable location

5.4 Conveyor Belt

Conveyor belt systems are widely applied in many industries. The materials carried include packaging, assembled materials and minerals, including coal. Due to the easy spread of a fire within these systems, the damage caused by these types of fires can be great, so early detection is critical.

Typically, there are two kinds of fires identified with the conveyor belt system:

- “Static fire” on the belt mechanism or belt system.
- “Moving fire” on the moving belt.

As an example, coal generates dust during conveying that can accumulate on the roller bearings. The dust accumulation ignites due to friction caused by the breakdown or wear of the roller bearings. Additionally, the static friction of the belt can ignite the coal dust.

In the past, many kinds of fire detectors have been used, including ionisation and photoelectric smoke detectors, point-type temperature sensing detectors, point-type flame detectors and pneumatic detectors. Experiments have shown that these detectors, in most cases, do not adapt to this kind of environment and cause false alarms due to the powdery dust and fine water spray mist used to control the dust. To combat the false alarm problems caused by dust, point type detections systems may reduce their sensitivity, resulting in a time lag for alarm detection. LHDC has gradually become an industry standard and choice for protecting these systems, especially at those locations within the system where environmental conditions are extreme and false alarms are reported frequently. Wismart offers a wide variety of products to meet conveyor system fire protection needs.

What about the “moving fire” on the belt? Experiments have shown that it is difficult to detect a small fire moving at a speed of 2 m/s to 4 m/s with point type detection systems or standard line type heat detectors. The temperature rate-of-rise function of TraceLine™ has an improved response capability, as compared to point type detection systems and standard LHDC. The environmental compensation function guarantees self-adaption to the environmental changes without decreasing sensitivity, so that brings a newer and more effective solution for detecting conveyor belt moving fires.

The design of the detection zones requires the designer to consider the following:

Physical barriers, Fire Zone or Fire Breaks

Access ways etc., for fire fighting personnel

Zoning of Deluge System or other extinguishants

A “zone” is a length of Line Type Heat Detecting Cable connected to a MCU, with the MCU being housed in a protected area. The length of detecting cable in any zone is determined by the “Characteristics of Line Type Heat Detecting Cable Systems”. When confronted with long distances between the detection zone and the MCU, special low capacitance extension cable is available.

The MCU provides remote monitoring signals which can be monitored at a central location.

Installation examples are shown in Figures 5.7 and 5.8.

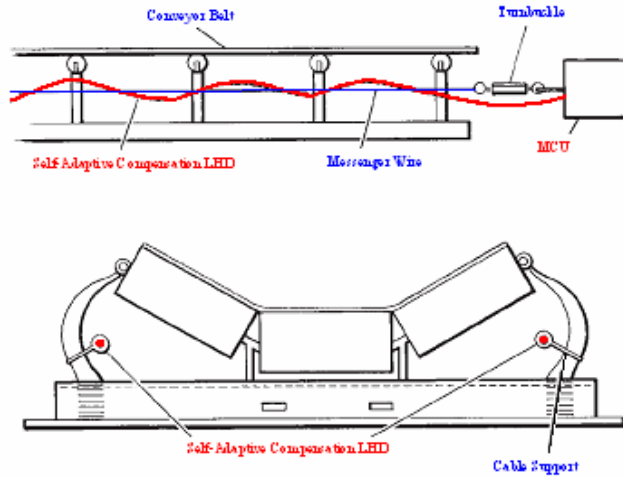

Figure 5.7 – Moving conveyor installation

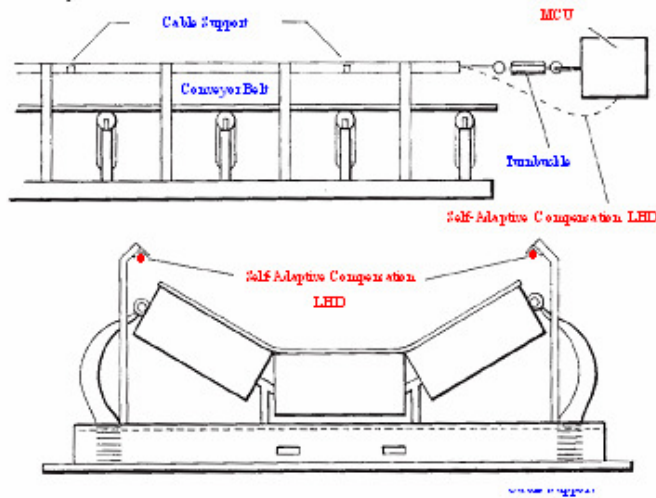

Figure 5.8 – Moving conveyor installation

5.5 Floating Roof Fuel Storage Tanks

There is a great deal of storage tanks with oil, liquid gas, natural gas, gasoline, benzene, etc., in industry or in a city. These tanks are flammable and explosive. They might cause great damage once a fire occurs and not found and controlled in time. Therefore, early detection and alarm is critical.

The characteristics of the storage tanks for petro-chem products:



Larger capacity measure

They are mostly located outdoors. The environment is quite poor for detector usage. Somewhere may be subject to $-30\text{ }^{\circ}\text{C}$ in winter and over $+45\text{ }^{\circ}\text{C}$ in summer, with direct exposure to the sun.

Clear possible fire hazard location

Mainly on the rim seal of the floating roof, monitor holes of the tank, instrument meters and valves.

An analogue heat sensitive detector needs to solve the following issues:

- Good corrosive endurance capability and strong anti-interference capability.
- Strong self-adaptive and compensation capability. It shall be capable of compensating the fast changing environmental temperature and avoid erroneous alarms from direct exposure to the sun.
- Usually the storage tanks of petro-chemical products are in a dangerous explosive potential area, so the detector itself has to be a safe product.

The MCU is designed to be located in a safe area and connect to the sensing cables with limited length interposing cables and Zener safety barrier. Due to the characteristic of equivalent capacitance of the interposing cable, the selection of the cable length has to meet the flame-proof requirements.

The installation of the detector on the floating roof is shown in Figures 5.9 and 5.10. With fixed top tanks the Line Type Heat Detecting Cable can be used to monitor vents, gauging points, and access holes in one continuous line. On floating top tanks, the top seal can be monitored and the Line Type Heat Detecting Cable is easily arranged to cover movement of the floating roof.

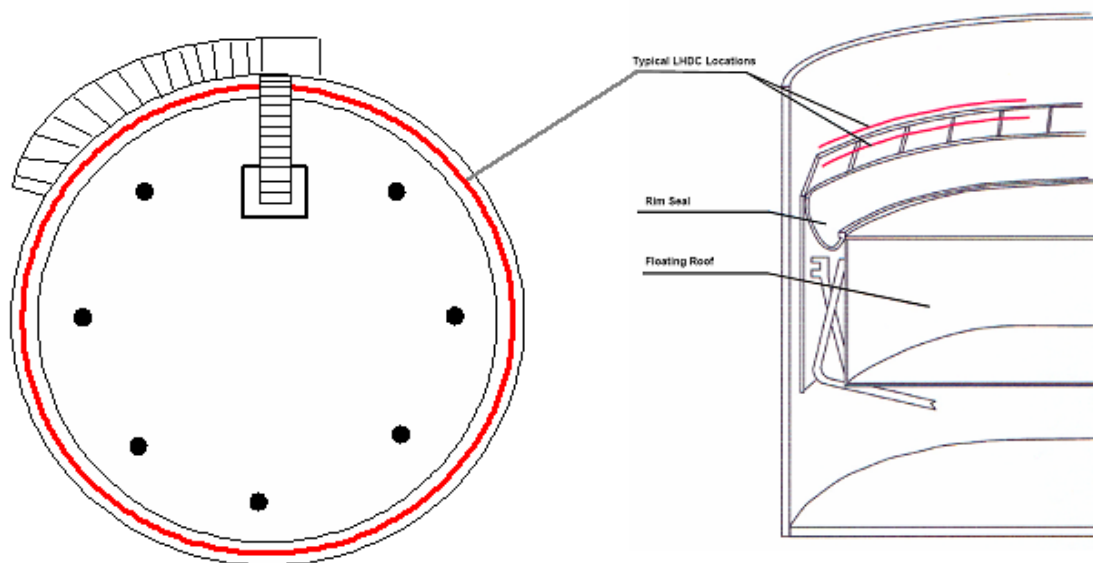

Figure 5.9 – Installation on a tank floating roof

Where there are relatively long distances between the detection zone and the MCU, low capacitance extension cable is available.

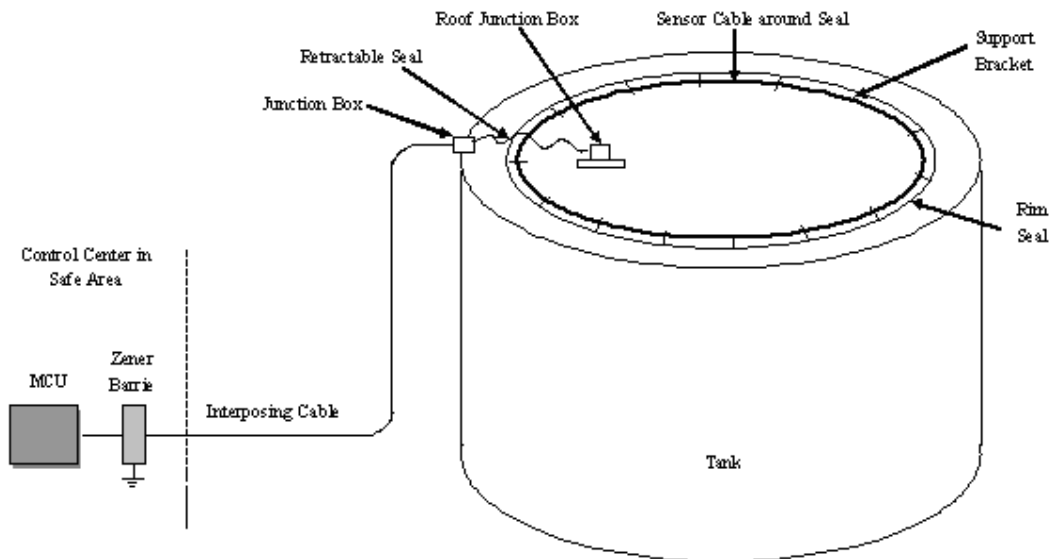

Figure 5.10 – Installation on a tank floating roof

5.6 Rack Storage and Freezer Warehouse

There are a large number of high density storage racking systems used within a warehouse or distribution centre, even in freezer warehouses. Usually these warehouses are constructed of steel. Once a fire occurs, the warehouse racking system is at risk of collapsing causing a “domino effect”. Therefore, early fire alarm detection and pre-alarm detection is critical in minimizing fire damage. Typically, air sampling type systems are used to protect storage racking systems, but they have difficulty with dusty and very low temperature environments.

TraceLine™ can be used for fire alarm detection within the shelving of a high-density storage racking system as well as between the partitions of a high-density storage rack system. Testing shows that LHDC typically responds very quickly to a fire event, effectively avoiding significant loss.

The temperature rate-of-rise alarm function of the NBC800/FR provides faster high-density storage racking system fire detection and NBC800L/FR may offer more precision in pinpointing possible hot spots and fire locations, thus shortening the actual fire location judgment time.

There are different LHDC installation methods for different high-density storage racking systems, as shown in Figure 5.11.

The racking area may be divided into “zones” based on the following:

- Physical Barriers and Fire Protection Zone*
- Access ways etc., for fire fighting personnel*
- Zoning of Deluge System or other extinguishants*

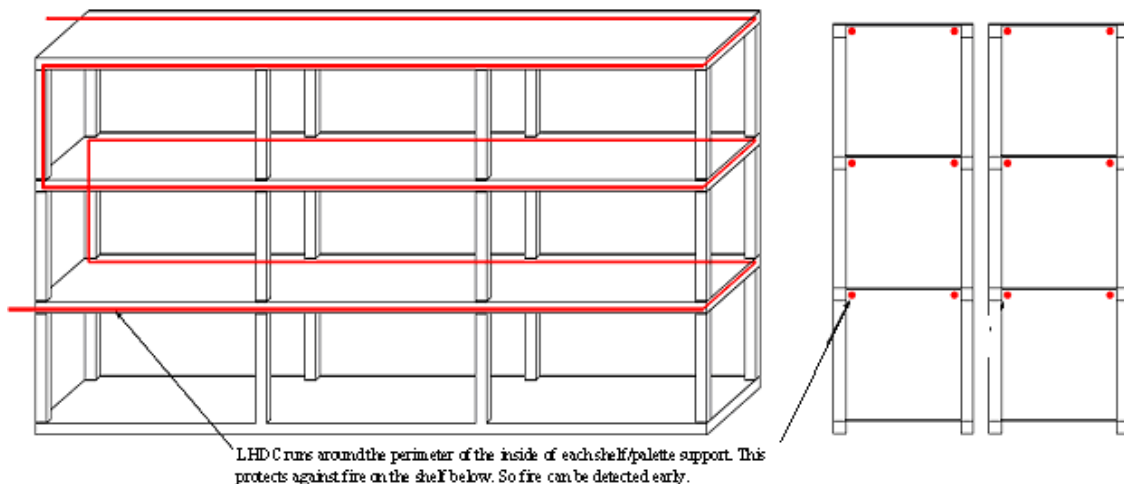

Figure 5.11 – Installation in rack storage

Each zone requires a length of Line Type Heat Detecting Cable and a MCU, which may be located adjacent to the zone in a protected area. The MCU typically provides the deluge system actuation signal, as well as remote monitoring signals, which can be monitored at a central location.

The installation for a freezer warehouse is similar to that for rack storage, however precautionary measures need to be taken to ensure trouble free installation and operation, as the following:

- The TraceLine™ sensor cable that is used in this application is the special material coated type LHDC with a minimum operating level -40 °C.
- Installation should take place in temperatures no lower than -11 °C.
- Bends within the sensor cable should not exceed 100 mm radius. Fixing of the cable should be at 1 m ~ 1.5 m intervals and either side of all bends.
- Use neoprene between clips and sensor cable to ensure the cable is not pinched by the clip and prevents the clip acting as a heatsink.
- All sensor jointing and terminations must be made within waterproof boxes suitable for the temperatures to be encountered.
- All electronic interfaces and display units should be installed outside of the low temperature area.

5.7 Petrochemical Product Pumps

The mechanical failure of a petrochemical pump can in many cases cause a fire. The intrinsically TraceLine™ model may be employed to monitor one or more pumps.

Generally a failure of the pump motor or a mechanical coupling causes seal failure, therefore the most likely source of fire is in the seal area. A loop of Line Type Heat Detecting Cable (LHDC) above the seal provides early detection while being flexible enough to be held aside during the required maintenance work.

A line of pumps may be monitored in any one “zone” and therefore TraceLine™ is a more cost effective solution.

A “zone” is a length of Line Type Heat Detecting Cable connected to a MCU, with the MCU being housed in a protected area. The intrinsically safe circuitry within the MCU imposes a limitation on cable length because of the capacitance of the Line Type Heat Detecting Cable. The maximum

permissible length varies with the Hazardous Gas Groups within the protected zone.

The MCU provides remote monitoring signals, which can be monitored at a central location.

5.8 Boiler and Furnace Burner Areas

On all types of boilers and furnaces there is a high risk of fire in the area of the burners.

The ambient temperatures and physical restraints often preclude many forms of detection systems; however, TraceLine™ can be employed giving early warning of fire conditions in the burner area.

The ambient temperature must be considered and it should be noted that the Line Type Heat Detecting Cable (LHDC) can operate with long-term ambient temperatures up to 70 °C.

The detection cable is typically placed on a horizontal framework so that approximately 10 metres of cable covers an area of 1 m². The framework is placed above each burner or group of burners, so as to monitor the incoming fuel line or ducting.

The arrangement of the “zones” of detection is generally determined by the fire fighting procedures, but it is practical to cover a number of burner areas as a single “zone” where discrimination between burner areas is not required.

Each zone will require a length of the appropriate Line Type Heat Detecting Cable and a MCU.

The MCU can be mounted adjacent to the detection zone and provide an actuation signal for deluge system or other extinguishing system. The MCU provides remote monitoring signals, which can be monitored at a central location. Where this cable traverses other zones, it should be fire resistant rated.

5.9 Power Distribution Equipment

TraceLine™ sensor cable should be interlaced through components in a horizontal pattern, fastened to the panel using approved fixings. The sensor cable can also be installed in parallel with the wiring harness of an electronic switchgear panel. Other equipments, such as transformer, switchgear, substations, resistor banks etc, can be protected in the same manner.

Figure 5.12 shows one example of this type of installation.

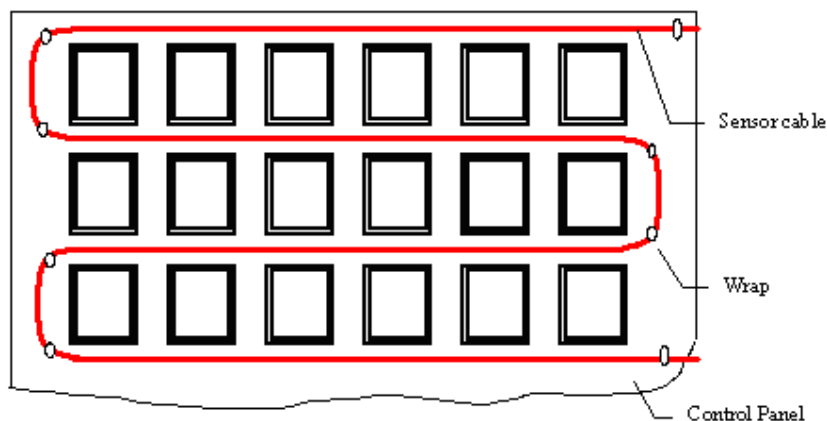

Figure 5.12 – Sensor cable interlaced within power distribution equipment

5.10 Flammable Oil Area and Transformer

For many harsh oil environments, such as an underground oil station, oil pipeline tunnel and transformer, it is not suitable to use a conventional fire detection system. TraceLine™ can be used primarily in these areas to achieve reliable detection by interlacing directly to the protected objects or linearly hanging beside the protected objects. Figures 5.13, 5.14 and 5.15 show some examples of installation.

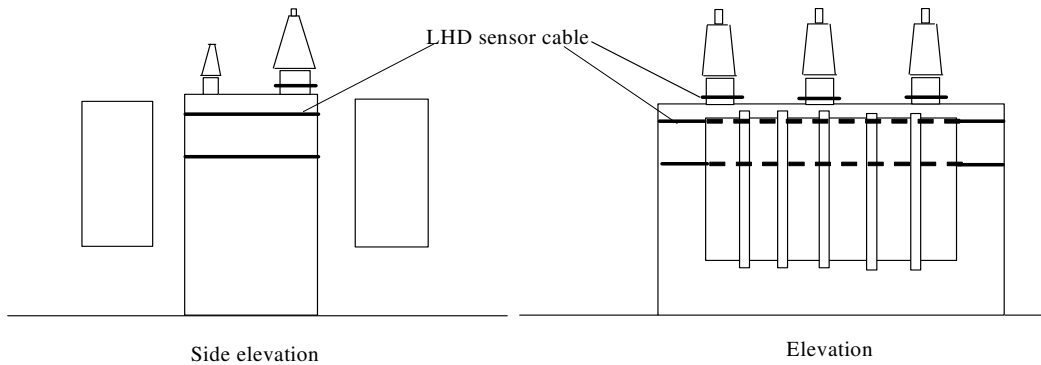

Figure 5.13 – Sensor cable layout for transformers

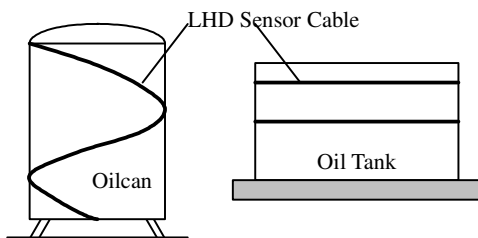

Fig 5.14 Sensor Cable layout for Oil Equipment

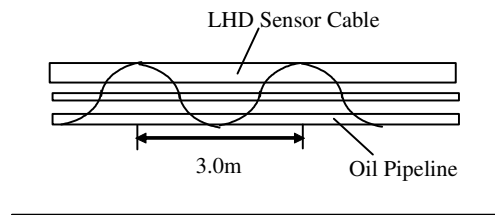

Fig 5.15 Sensor Cable Layout for Oil Area

5.11 Escalators

TraceLine™ sensor cable provides total protection of an escalator with coverage provided at all potential fire risk areas i.e. drive motor, return roller bearings, dust collection tray and truss rollers. The use of the bronze braided sensor cable option is recommended together with temperature sensor pads strategically located at primary risk locations.

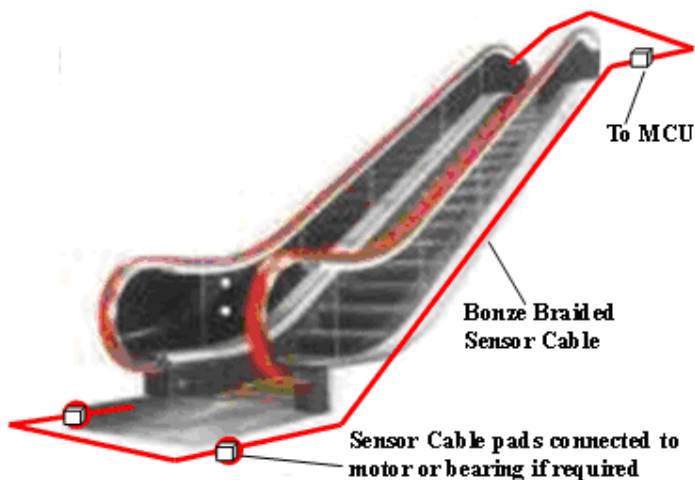

Figure 5.16 – Escalator detection

Where protection is considered for escalator retrofit rather than a new construction stage, restricted access to truss rollers may limit protection to the electrical plant at each end of the escalator. This will provide protection of high risk areas i.e. return roller, dust collection tray and drive motor.

6 Design Considerations

6.1 Sensor Cable Selection

6.1.1 Fixed Temperature Detecting Cable, /F Type

Fixed temperature detecting cable is recommended for areas where the environment temperature varies hourly or the maximum value may be higher than 42 °C, such as outdoor areas, boilers and furnaces burner areas, floating roof fuel storage tanks, etc.

6.1.2 Rate-of-Rise Heat Detecting Cable, /R type

Rate-of-rise heat detecting cable is recommended for areas where the environment temperature is steady, where the maximum value is less than 42 °C, such as indoor areas, underground areas, etc.

6.1.3 Fixed Temperature and Rate-of-Rise Heat Detecting Cable, /FR type

Fixed temperature and rate-of-rise heat detecting cable is recommended for areas where the environment temperature is relative steady, where the maximum value is less than 42 °C and it is important to an early alarm according to rate-of-rise temperature characteristics, such as cable tray and racks, underground oil stations, some warehouse, road or railway tunnel, etc.

6.1.4 High Temperature PVC Coated Sensor Cable

High temperature PVC coated sensing cable is recommended for environments ranging from clean and dry to moderate dust and moisture. PVC coated sensor cable is not suitable for external use or for installations where corrosive agents or damage to the cable may occur.

Typical Installations:

- Cable trays and racks (cable tunnel, cable room etc.)
- Indoor space (hangar, underground oil station etc.)
- Electrical switch gear or equipment
- Service ducts
- Car parks
- Tunnels (road or railway)
- Conveyors/escalators, where there is no risk of mechanical damage

6.1.5 Polytetrafluoroethylene Coated Sensor Cable

Polytetrafluorethylene coated sensor cable is recommended for harsh environments, petrochemical, cold warehouse and outdoor use in general. Polytetrafluorethylene coated sensor cable can also be used in areas where the standard sensor cable is used if more rigidity or a discreet installation is required:

Typical Installations:

- Floating roof tanks
- Cold warehouse

- Silos and driers
- Tank storage areas
- Engine bays
- Paint spray areas
- Oil rig open area protection
- Areas subject to chemical contamination
- Car parks where unsupervised

6.1.6 High Temperature PVC and Bronze Braided Sensor Cable

High temperature PVC with bronze braided sensor cable is recommended for areas where friction or mechanical damage may occur or explosive gas/dust may exist. Other installations suitable for the high temperature PVC coated sensor cable are also appropriate.

6.1.7 Polytetrafluoroethylene and Bronze Braided Coated Sensor Cable

Polytetrafluoroethylene with bronze braided coated sensor cable is recommended for areas where friction or mechanical damage may occur or explosive gas/dust may exist. At the same time, corrosive agents or damage to the cable may occur. Other installations suitable for the polytetrafluoroethylene coated sensor cable are also appropriate.

6.1.8 Location Type Sensor Cable

Location type sensor cable is recommended for areas where it is necessary to know the overheating or fire spot, such as road tunnel, cable tunnel, oil pipeline tunnel, etc. /F, /R, /FR alarm characteristics are also suitable for these applications.

6.1.9 Other Types of Cable

Other special types cable can be manufactured according to the customer's demand, such as nylon coated sensor cable, etc.

6.2 MCU Selection

The MCU has IP66 rating, so it can be used in many harsh environments.

6.2.1 Fixed Temperature Alarm MCU

The fixed temperature alarm MCU should be used with /F type sensor cable and is recommended for the same areas as /F type sensor cable.

6.2.2 Rate-of-Rise Heat Alarm MCU

The rate-of-rise heat alarm MCU should be used with /R type sensor cable and is recommended for the same areas as /R type sensor cable.

6.2.3 Fixed Temperature and Rate-of-Rise Heat Alarm MCU

The fixed temperature and rate-of-rise heat alarm MCU should be used with /FR type sensor cable and is recommended for the same areas as /FR type sensor cable.

6.2.4 Locating Type MCU

The locating type MCU should be used with /L/F or /L/FR type sensor cables and is recommended for the same areas as /L/F and //FR type sensor cables.

6.3 Application Considerations

The TraceLine™ sensor cable can cover a wide and diverse range of applications. Cable selection can therefore be based upon the environmental conditions pertaining to the associated risk.

The alarm response threshold of the MCU, required for the correct operation of the system, is set through the configuration and commissioning software. This will enable the system to be commissioned against the known environmental temperature of the installation and ensure best results for each installation.

Because TraceLine™ LHD has the self-adaptive compensation function, there is no need to change settings following commissioning of the installation. However, it is important to understand the varying characteristics of environment temperature to set MCU more precisely.

Generally, when the environment temperature varies quickly and by a large amount, then levelling the self-adaptive compensation at the third level should be used. When the environment temperature varies slowly, but by a small amount, then levelling the self-adaptive compensation at the second level should be used. For normal environment, levelling the self adaptive compensation at the first level should be used. Thus, the system will maintain the optimum operation.

6.4 Intrinsically Safe Applications of LHDC

When TraceLine™ is used in explosive areas, design should be made as shown in Figure 6.1.

When deciding to choose a safe barrier, it is necessary to consider the parameters of equivalent capacitance, inductance and L/R ratio of sensor cable, interposing cable, junction box and EOL box. The maximum permitted parameters should be less than the parameters of the safe barrier. A detailed introduction is given in the LHDC Installation section of this manual.

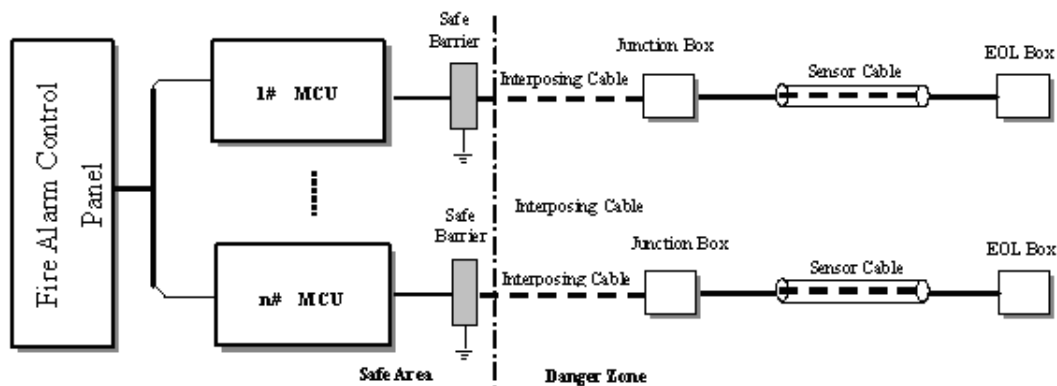

Figure 6.1 – Ex barrier configuration

7 MCU Installation

7.1 Description

Mounting of the MCU in accordance with the following.

- a) Slacken the four retaining screws and ease the lid away from the base.
- b) Mount the base to the appropriate wall/structure via at least two of the four securing points. Use 5 mm ~ 6 mm screws or bolts, with a minimum length of 15 mm ~ 25 mm.
- c) Fit cables to the PG entry locations on the side of the enclosure. The first entry location is used for input and output power supply cable. The second entry location is for the relay output and RS 485 cable. The third entry location is for sensor cable or interposing cable. Cables should be fixed to the enclosure carefully to maintain IP66 rating of the enclosure.

Do not remove the PCB otherwise damage may result.

7.2 Installation Dimensions

The outline dimension of the MCU enclosure is (200H x 138W x 70D) mm. The installation holes dimension is (188H x 107W) mm. Four deep installation holes will be used to fix the MCU on metope or in electrical box. Generally, several MCUs may be installed together in the same place or electrical box.

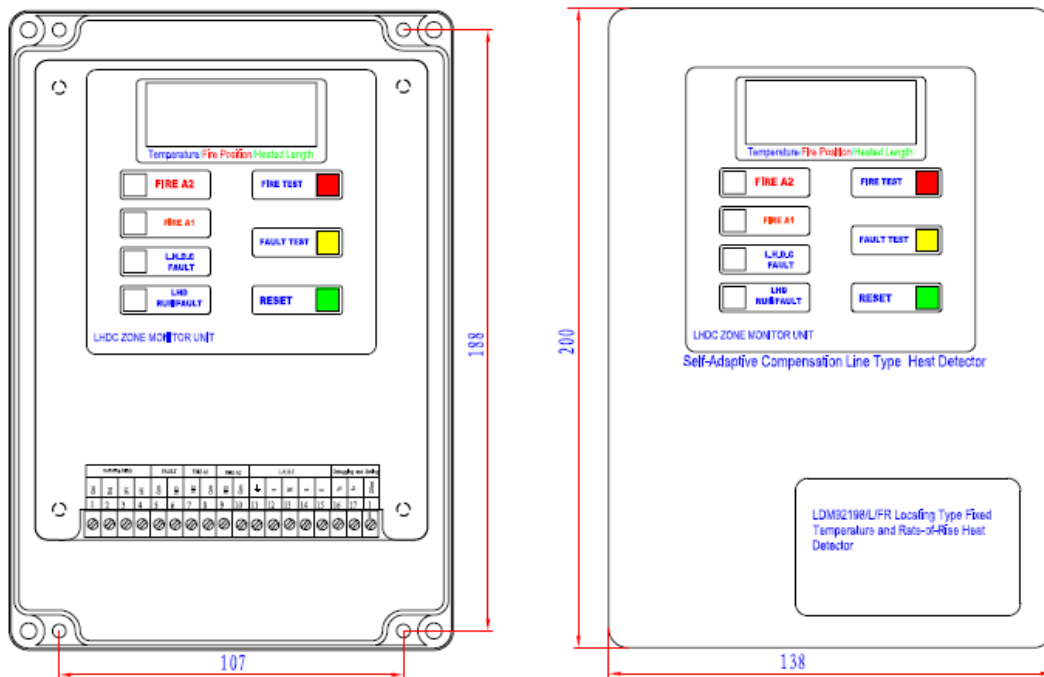

Figure 7.1 – Monitor and control unit

7.3 Connections

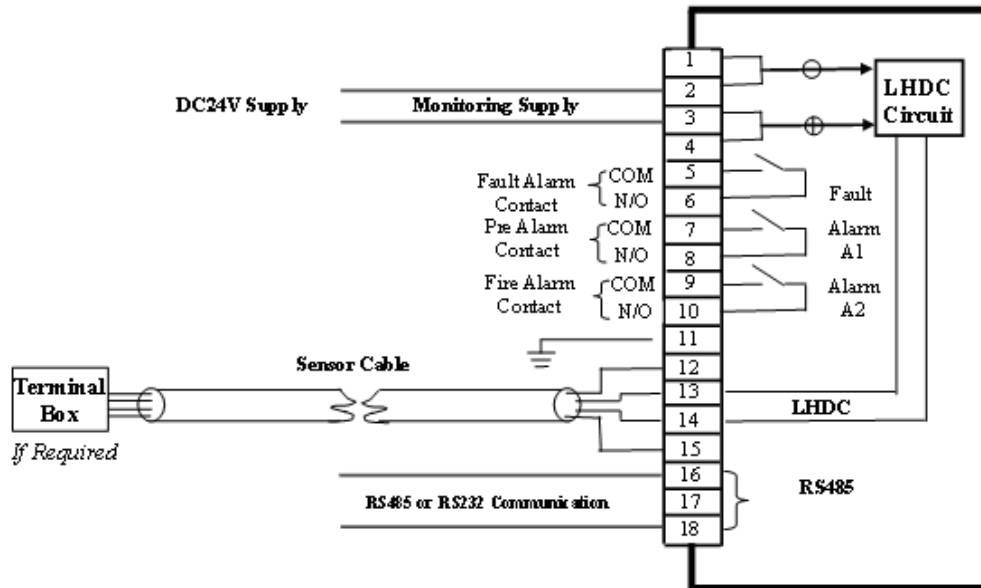

Figure 7.2 – MCU terminals

Table 7.1 – Terminal connections

1	Power supply 0 V	11	Earth
2	Power supply 0 V	12	Sensor cable 1 (red)
3	Power supply 24 VDC	13	Sensor cable 2 (white)
4	Power supply 24 VDC	14	Sensor cable 3 (blue)
5	Fault contact relay (COM)	15	Sensor cable 4 (orange)
6	Fault contact relay (N/O)	16 ^{a)}	Transmit
7	Fire A1 (N/O)	17 ^{a)}	Receive
8	Fire A1 (COM)	18 ^{a)}	GND
9	Fire A2 (N/O)		
10	Fire A2 (COM)		

^{a)} RS 485 or RS 232 communication

Note:

1. The MCU can be reset by interrupting 24 V power supply via a suitable switch or by pressing “RESET” button on the front of the MCU.
2. For rate-of-rise and fixed temperature type detector, Fire A1 displays the rate-of-rise alarm and Fire A2 displays the fixed temperature alarm. For fixed temperature type detector, Fire A1 displays pre-alarm (the first level alarm) and Fire A2 displays the alarm (the second level alarm).
3. Terminal 11 is used for explosive-proof type TraceLine™ or shielding type TraceLine™.

7.4 Wiring Details

7.4.1 Connection With the Fire Alarm System

Generally, TraceLine™ can be connected to most fire alarm systems through an input module. In order to get pre-alarm and alarm signal, it is necessary to use two one-input module or one dual-input module, one input for pre-alarm, another one for alarm and fault (see Figure 7.3). The terminal resistor value of input module should be specified by the fire control panel of manufacturer.

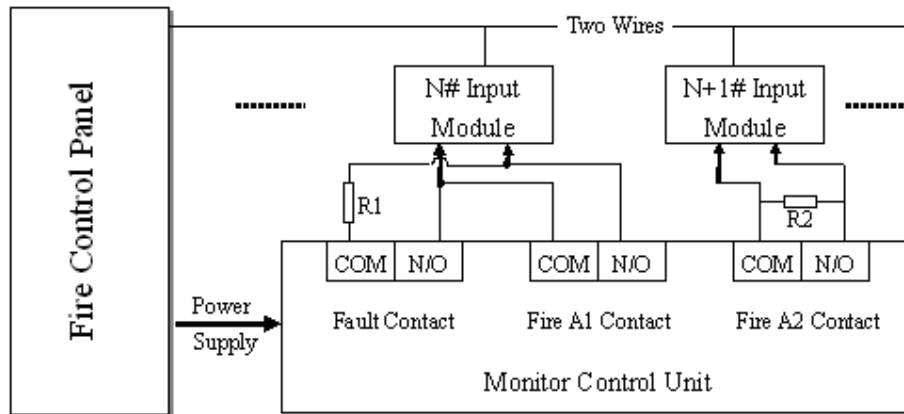

Figure 7.3 – Connection to a fire control panel

7.4.2 RS 485 FieldBus Connection Mode

TraceLine™ has flexible bus communication. TraceLine™ can be used conveniently, especially for applications such as road tunnel, cable tunnel etc. In this mode, a Bus Relay Device is used to connect MCUs by RS 485 FieldBus with one loop of FieldBus connecting to less than 128 MCUs. Bus Relay Device has an RS 485 or digital output to connect with fire alarm control panel.

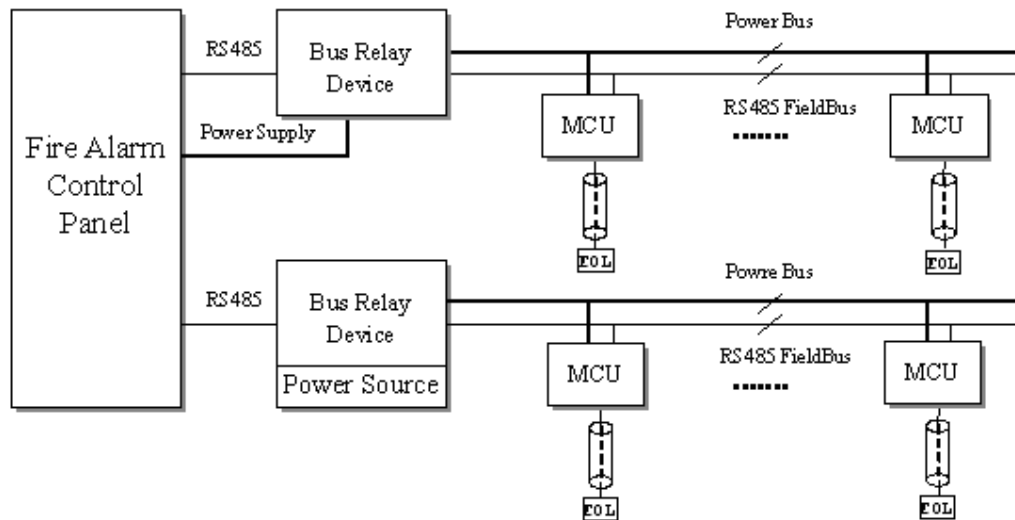

Figure 7.4 – RS 485 fieldbus mode

7.5 Function of Control

Figure 7.5 shows the front panel of MCU. The function of each control and indicator is described below.

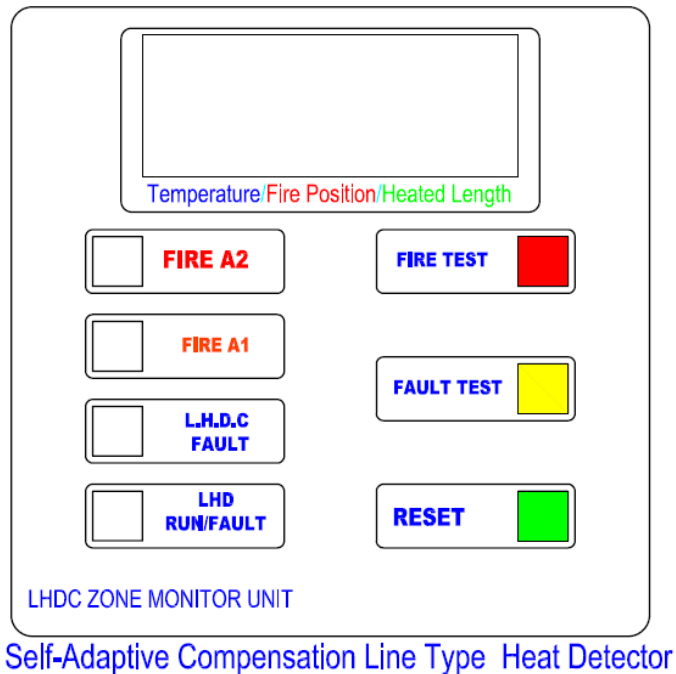

Figure 7.5 – MCU front panel

Temperature/Fire Position/Heated Length Display

For normal type MCU, the display shows the type of LHD, or equivalent environment temperature (if specialized requirement from customers). For Location type, the display also shows fire (or overheating) position.

Fire A2 LED

Continuous operation indicates alarm for fixed temperature, and the overheating of fire condition.

Fire A1 LED

Continuous operation indicates pre-alarm for fixed temperature or alarm for rate-of-rise temperature, and the overheating of fire condition.

LHDC Fault LED

A yellow LED indicates a sensor cable fault within SuperLine system, either open or short circuit.

LHD Run/Fault LED

A green LED indicates normal system operation. A yellow LED indicates a system fault, either low power or PCB fault.

Test: Fire and Fault Switch

To test for a pre-alarm and fire alarm indication, press the fire test button for up to 2 seconds

Zeta Alarm System.

and ensure the fire FIRE A1 LED is lit. Then after a 2 second interval, press the fire test button again for up to 5 seconds and ensure the FIRE A2 LED is lit.

To test for a fault indication, press the fault test button for up to 2 seconds and ensure the fire FAULT LED is lit.

To reset the system, press Reset Button.

The parameters setting software can also be used to monitor alarm and fault conditions.

8 TraceLine™ Installation

8.1 Installation Overview

TraceLine™ can be used for a wide range of applications (refer Section 5). However, design information and cable selection should be undertaken by the company supplying such equipment or a company authorized by Wizmart, especially the parameter setting.

The installation mode is decided by the protected object or space, risk characteristic and anticipant detection performance. Generally, two type installation modes are used. One is where the sensing cable is in direct contact with the surface of protected object, such as Sine lay on the cable tray. Another is where the sensing cable is suspended from the surface, such as laying under the roof space or adjacent to the protected objects.

Positioning of units depends upon site requirements. Mounting adjacent to the risk area is preferable although not essential. Interconnecting cable can be used to connect to the MCU and should be four-core 1.5 mm², with a maximum distance of 2km. Figure 8.1 shows an example of the field wiring setup.

Generally, 2 m ~ 3 m of sensor cable should be left available in order to do test.

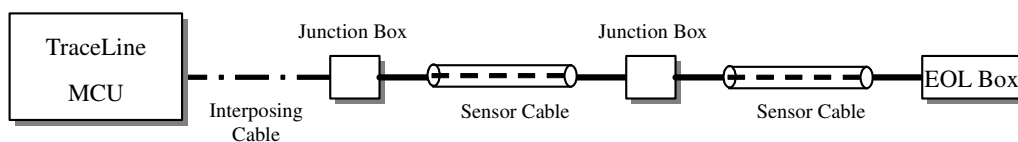

Figure 8.1 – General installation configuration

8.2 Hazardous Areas

When TraceLine™ sensor cable is used for explosive areas, it is essential that appropriate Zener barriers are installed within suitable enclosures for the environment. Both the Zener barrier and Zone MCU must be located in a designated “Safe Area”.

Two dual Zener barriers per sensor cable are required. 5 V to 12 V zener barrier units are recommended, in combination with the range of MCU. For typical connection see Figure 8.2 below.

Approved barriers are :

1. Measurement Technology MTL761
2. Pepper & Fuchs 2361EX

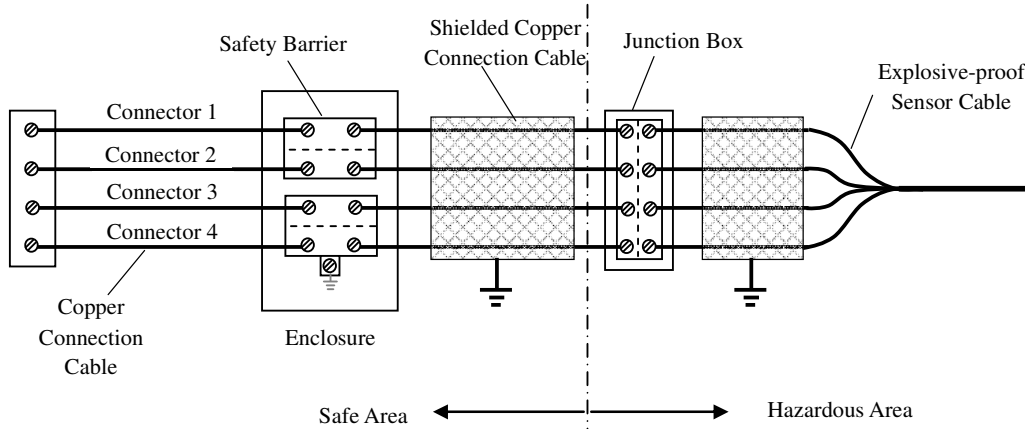

Figure 8.2 – Hazardous area barriers

8.3 Cable Fixings

8.3.1 General

Fixing devices for the sensor cable are readily available for most applications. Owing to the nature of the sensor, no special rules need to be followed, other than to ensure the fixing device does not damage the sensor cable (as with any electrical installation). Clamping should not be excessive.

The sensor cable can be bent around a radius of 10 mm. Should the bend be providing an anchor point in order to apply tension, the bend radius should be 20 mm to 25 mm. The cable should be fixed at both sides of any bends.

A short length of neoprene sleeving provides protection at the fixing point and is recommended especially where sharp edges are likely to cut into the insulation or where metal braided sensor can chafe against surrounding metal or where the clip may act as a heatsink.

The following samples are the most commonly used range of fixing clips.

8.3.2 Edge Clip

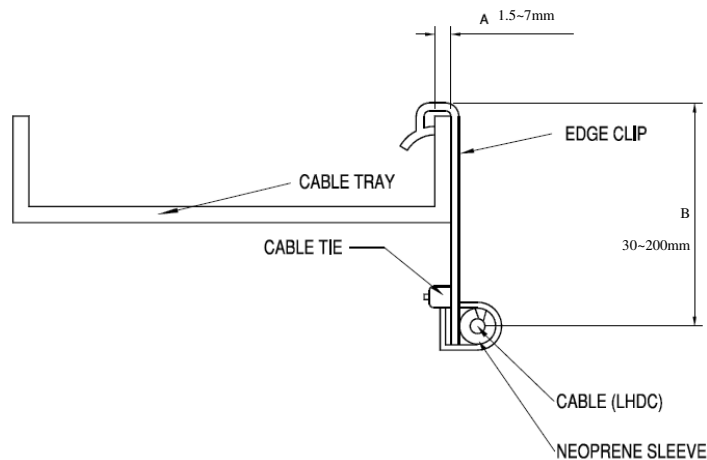

Figure 8.3 – Edge clip

8.3.3 Knock on Clip

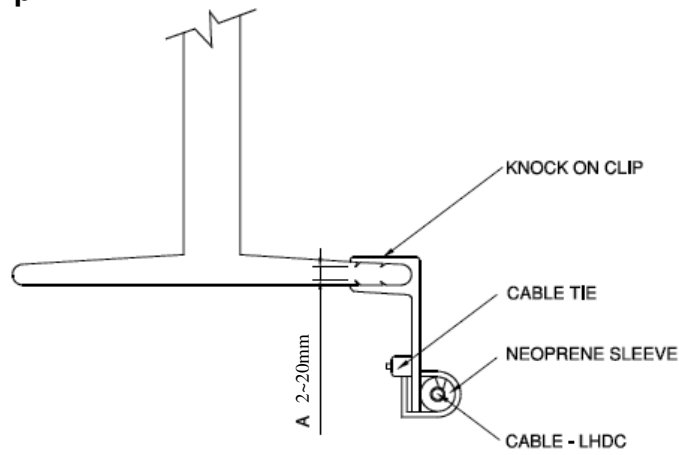

Figure 8.4 – Knock-on clip

8.3.4 Thermal Spacer

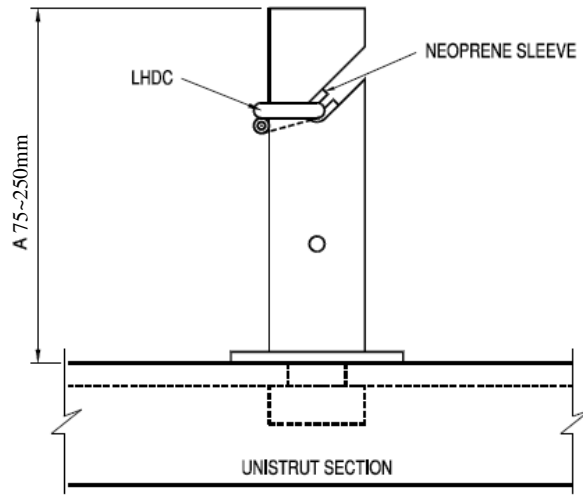

Figure 8.5 – Thermal spacer

8.3.5 V-Type Clip

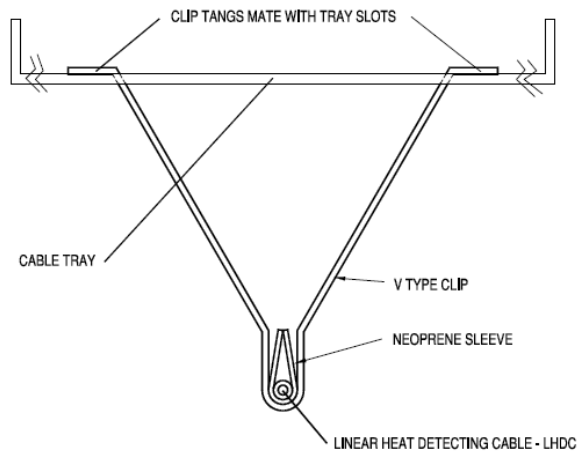

Figure 8.6 – V-type clip

8.3.6 T-Type Clip

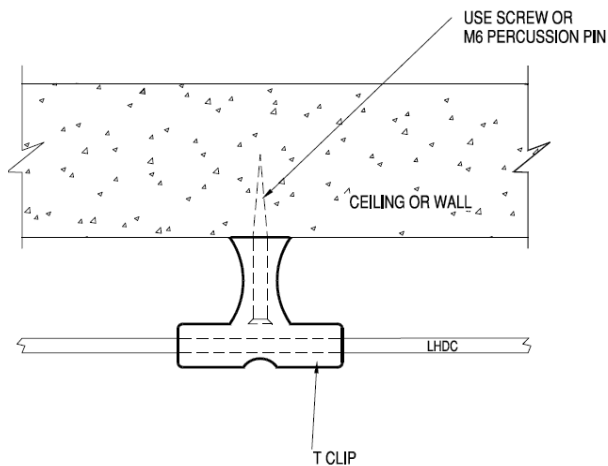

Figure 8.7 – T-type clip

8.3.7 L Bracket

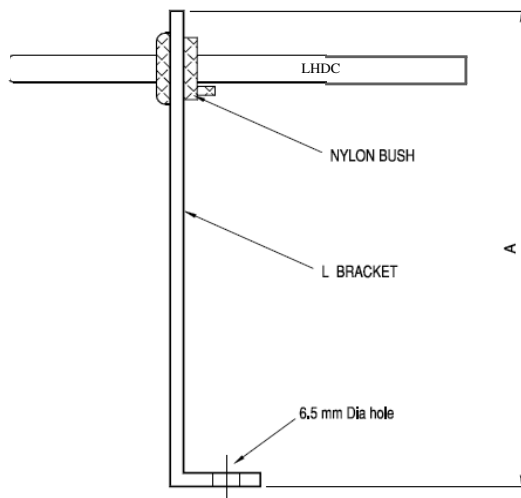

Figure 8.8 – L bracket

8.4 Junction Box and EOL box

8.4.1 General

Four types junction boxes and EOL boxes are available for any applications

- JB92198 normal type junction box
- EOL92198 normal type EOL box
- JB92198EX explosive-proof type junction box
- EOL92198EX explosive-proof type EOL box.

The installation hole dimensions are (50H x 70W) mm.

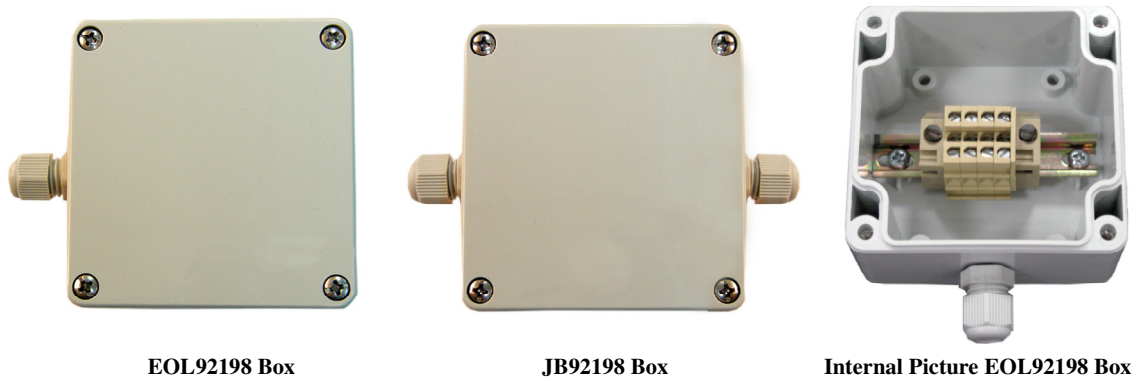

Figure 8.9 – Junction boxes

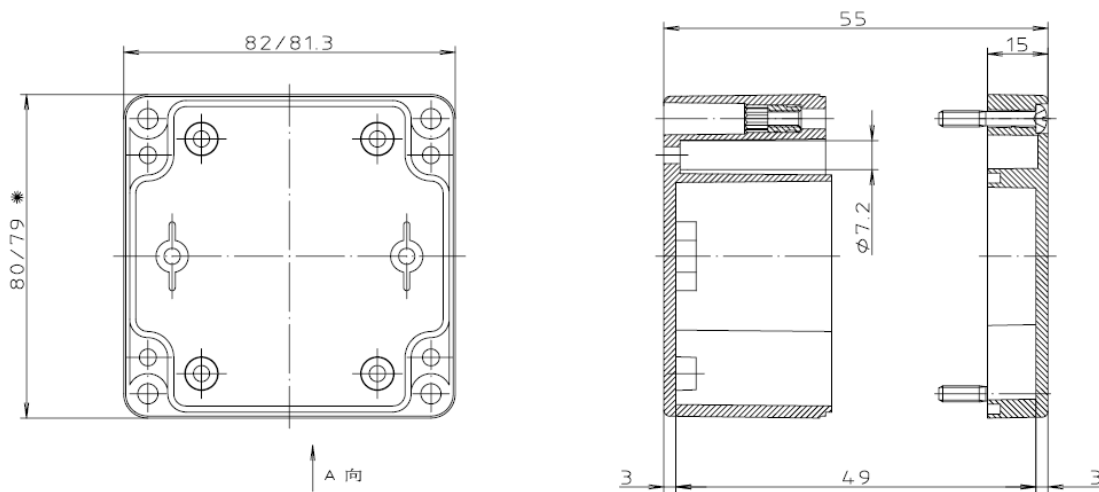

Figure 8.10 – Junction boxes

8.4.2 Technical Specification

JB92198, EOL92198

Material: Polycarbonate or ABS to IP66~67

Size: (80H x 82W x 55D) mm

Colour: Grey (RAL 7035)

Weight: 0.05kg

Terminals: Four terminals, AKZ1.5 (Maximum conductor diameter: 1.5 mm)

PG7 tie-in: Polycarbonate or ABS

JB92198EX, EOL92198EX

Material: Polyester to IP66~67

Size: (75H x 80W x 55D) mm

Colour: Black

Weight: 0.06kg

Terminals: Five terminals, AKZ1.5 (Maximum conductor diameter 1.5 mm)

PG7 tie-in: Brass coated nickel

8.5 Cable Stripping

The head and end of the TraceLine™ sensor cable must be stripping before connecting to junction box, EOL box or MCU.

1. Place the end of the TraceLine™ sensor cable flat on a smooth and stable surface.
2. Starting 15 mm ~ 20 mm from the end, make a straight slice through the outer sheath only, as shown in Figure 8.11 below.

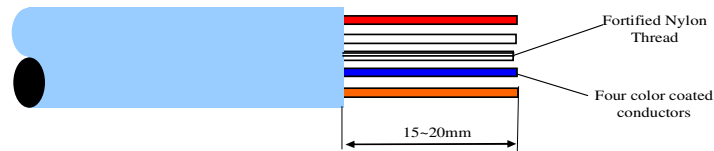

Figure 8.11 – Strip outer sheath

3. Peel back the outer sheath, exposing the four coloured inner conductors and white fortified nylon line.
4. Remove up to 5 mm ~ 10 mm of insulation from each of the four coloured cores and cut the white fortified nylon line, as shown in Figure 8.12 below.

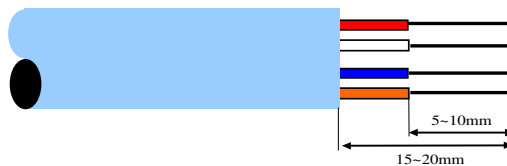

Figure 8.12 – Strip conductor insulation

5. Connect the sensor cable to terminals of junction box, EOL box or MCU.

8.6 Cable End Termination

Two modes can be used to terminate the end-of-line device. One is shrink sleeve mode; the other one is EOL box mode.

For shrink sleeve mode:

1. Prepare the end of the sensor cable as instructed in Section 8.5, steps 1-5.
2. Take the RED and WHITE cores, twist together and solder.
3. Take the BLUE and ORANGE cores, twist together and solder.
4. Insulate both of the soldered joints with the small shrink sleeves provided
5. Using an industrial heat gun, apply temperature until the sleeve shrinks securely around the cable.
6. Place the large clear shrink sleeve and then the black end cap over all four cable ends and shrink firmly into position, applying the same temperature as in step 5.

Figure 8.13 shows the completed termination.

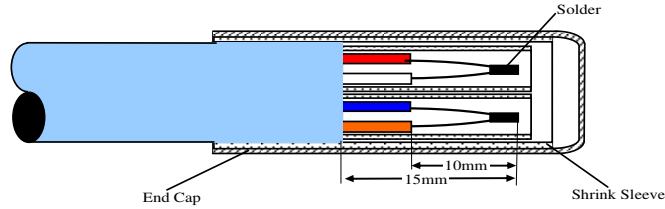

Fig 8.12

Figure 8.13 – Cable end termination using heat-shrink insulation

For EOL box mode, use a junction box with IP66 rating. In some harsh environments, silica gel may be used to cover the terminals (see Figure 8.14).

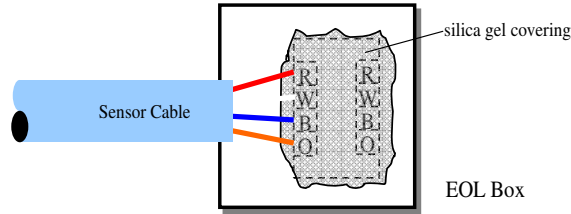

Figure 8.14 – Cable end termination using junction box

8.7 Cable Jointing

It is preferable to install sensor cable in continuous lengths, however in cases where it is necessary to join two sections of sensor cable together, or to insert an additional length, the following method should be used. The connection point of the sensor cable must be water tight seal (see Figure 8.15). The junction box must be IP66 rating upwards (see Figure 8.16). In many harsh environments, it is necessary to use silica gel to seal in the EOL box. Additionally, the fortified nylon thread in the cable should be tied together.

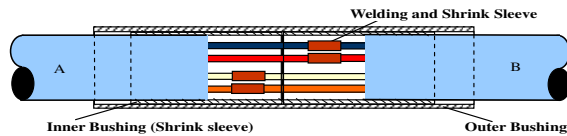

Figure 8.15 – Cable jointing using solder and heat-shrink insulation

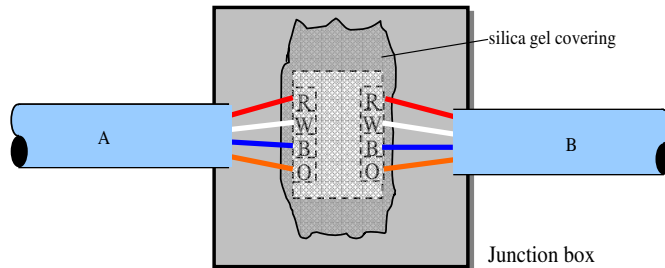

Figure 8.16 – Cable jointing using junction box

9 Commissioning

9.1 Preparatory

1. Check MCU, sensor cable, junction box, EOL box or safety barrier for correct installation and mounting.
2. Examine each sensor cable run to ensure that secure fixing and tensioning exists along its length, that it is free from mechanical damage and is installed to mitigate against future possible damage. It should be further checked to establish that the correct sensor option has been installed for the application.
3. Observe installation test certificates for monitor/supply cables or disconnect and “Megger” check.
4. Disconnect TraceLine™ sensor at both ends (MCU and EOL box) and “Megger” check screen to core and screen/core to earth. Ensure measured results exceed 1000 MΩ.
5. Re-connect EOL box and check for continuity from the MCU. For normal type LHD, resistance between red core and white core, blue core and orange core should be less 0.5 Ω/m average. For Location type LHD, resistance between red core and white core to should be 23 Ω/m average, and resistance between blue core and orange core should be less 0.5 Ω/m average.
6. Power on and ensure no fault information occurs.

9.2 Setting and Debugging

When default parameters of MCU are not suitable for the protected area, it is necessary to set and debug LHD according to the practical conditions. Generally, the following parameters need to be set:

1. Maximum environment temperature and the total length of the loop sensor cable.
2. Pre-alarm value and alarm value. The value should be set according to the former requirements.
3. Or rate-of-rise temperature speed.
4. Variational ratio DOC.E.T of environment temperature. In order to achieve better self-adaptive compensation capability, it is significant to input a suitable DOC.E.T level.

For location type LHD, follow the above procedures and then set the location calibration parameters through a test of the head and end of the sensor cable as shown in Section 11.

9.3 Procedure

9.3.1 MCU Self-test Functions

FAULT test:

With the MCU in the quiescent condition, press the FAULT TEST button on the MCU for 3 seconds to active FAULT alarm. Ensure that the FAULT LED lights and the FIRE LED remains off. Release the TEST button and observe that the FAULT LED remains on.

In order to reset the MCU, press “RESET” button or remove the power to the MCU.

FIRE test:

With the MCU in the quiescent condition, press the FIRE TEST button for 3 seconds on the MCU and ensure that the A1 (pre-alarm or rate-of-rise alarm) LED lights.

Press the FIRE TEST button for more than 5 seconds and ensure that the A2 (alarm) LED lights and the FAULT LED remains off. Release the TEST switch and ensure that the A1 and A2 LEDs remain on.

Reset the MCU and record the results.

Repeat the ALARM and FAULT test for any remaining TraceLine™ on the system.

9.3.2 Zone Integrity – FAULT

After the system is powered on, a FAULT signal should be registered at the fire control panel for relevant zone when the end-of-line or link between two of sensor cable connections is disconnected. Note that a short-circuit or open-circuit between the blue and orange conductors will not affect normal operation of TraceLine™, so the condition will not cause a FAULT signal.

9.3.3 Zone Integrity – FIRE

No uniform test requirements exist because the spot situation is different for each installation. Discretionary heat tests may be conducted to demonstrate the response of TraceLine™ to a sensor cable temperature rise. If conducted with naked flame, precautions must be observed to mitigate the risk of mishap and permanent damage to the cable.

Boiling water, portable heat oven or heat gun are recommended to be used for the heat test. To obtain a precise test, a heat oven should be used to produce a rate-of-rise in the temperature and fixed temperature value.

9.3.4 Sensor cable heat test**9.3.4.1 Boiling Water Method**

The sensor cable is a stable product. In many situations, it is not necessary to undertake a precise temperature test, so boiling water may be the best and easiest choice. Generally, 1 m of sensor cable immersed in boiling water will active pre-alarm and alarm conditions.

9.3.4.2 Portable Heat Oven Method

Commissioning and routine testing of TraceLine™ may be of benefit to the end user by providing site verification of the calibrated alarm temperature levels. This is best achieved by use of a portable heat oven. The oven is the most accurate method of testing by providing a controlled and monitored exposure to high temperature, without damage to the sensor cable.

Where this proves impractical (eg restricted access to a high level installed sensor cable) or impossible (eg hazardous/intrinsically safe environments), a 1 m length of sensor cable can be connected with sensor cable loop in safe area. Thus the conventional test method can be used.

9.3.5 Location Function

For location type TraceLine™, after installation and site calibration, the location function can be tested. If portable heat oven is available, precise alarm and overheating spot location results will be achieved. Generally, a computer will be used to receive data from the location type MCU in order to display the fire position.

10 Maintenance

10.1 Log

It is recommended that a system log is prepared during commissioning and used during maintenance to record all the information.

Subsequently, all system events should be recorded in the log. These should include all maintenance activity, fault warnings and fire occurrences (including where possible the apparent cause).

10.2 Routine Maintenance

10.2.1 General

Each length of sensor cable and its associated MCU should be considered to be a “detector” and be subject to the test/maintenance requirements specified in local codes and standards.

It is recommended that the procedure as defined in Section 10.2.2 be conducted each six months.

10.2.2 Procedure

1. Inspect MCU and sensor cable for correct fixing, mechanical damage and integrity of cover seals, cable termination, cable jointing etc.
2. Record a period time of realtime data using the LDS 2.0 software to analyse any abnormal variations.
3. Operate the Fire, Fault Test buttons to check MCU alarm functions and the wiring from MCU to fire alarm control panel.
4. If necessary, boiling water or a portable oven can be used to active simulative a fire alarm condition.
5. Record all test data in the log.

10.3 Fault Finding Procedures

10.3.1 Monitoring Panel – Fire Mode

1. Fire condition indicated at MCU

Indications: Pre-Alarm or Alarm LED: On

Other LEDs: Normal

Fire relay contact: Abnormal

Check for a fire condition in the protected area.

If no fire condition exists, it is necessary to investigate the ambient condition/hot spot, then to set TraceLine™ according to the new situation.

2. No fire condition indicated at MCU

Check for fire condition in protected area.

If no fire condition exists, investigate the wiring from MCU to fire alarm control panel.

10.3.2 Monitoring panel – Fault Mode

1. Fault warning indicated at MCU

Indications: FAULT LED: On

Other LEDs: Normal

Fault contact: Abnormal

Check for sensor cable, connections, EOL and wiring of sensor loop.

2. No Fault warning indicated at MCU

If no fault condition, check the wiring from MCU to the fire alarm control panel.

3. No green normal indicator

Investigate supply source and associated monitor/supply cables.

11 Calibration for Location Type TraceLine™

To meet the needs of special applications, a precise location of the source of heat may be required. After setting the parameters, Location type TraceLine™ only performs low precision locating. If precise length of every loop of sensor cable is provided before manufacture, calibration of TraceLine™ can be done at the factory, thus there is no need to do location calibration operation at the site. Otherwise locating calibration should follow the steps below.

1. Ensure the correct connection of the sensor cable and MCU.
2. Coil 1 m of cable at both ends of the cable (see Figure 11.1).
3. Power on TraceLine™ (see Figure 11.2).

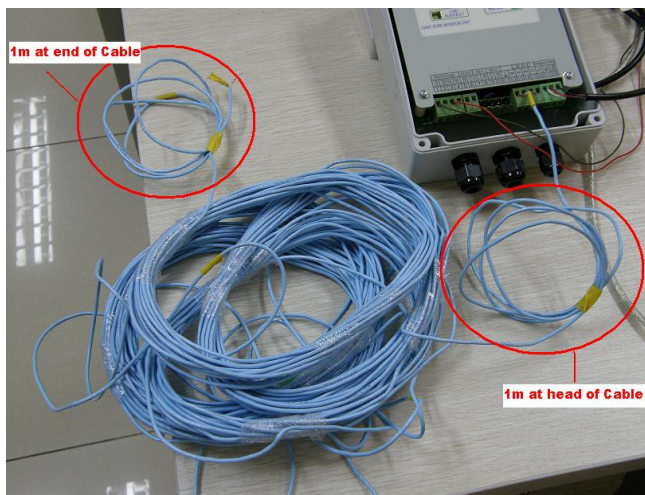

Figure 11.1 – Coil 1 m of cable at both ends of the cable



Figure 11.2 – Power on MCU

4. Set the parameters in accordance with Section 4.
5. Reset the MCU.
6. Power on the portable heat oven and set the temperature to 120 °C.

7. After at least 2 minutes, press the FIRE TEST button and FAULT TEST button together until the display shows “HOL” (see Figure 11.3). TraceLine™ is acquiring the location parameter for the head of line.



Figure 11.3 – Location parameter for the head of the line

8. Place 1 m of line at head of cable into portable heat oven until the display shows flashing “PA”.
9. Remove the cable from the portable heat oven.
10. Power off TraceLine™ and wait for the cable to return to the quiescent temperature.
11. Powered on TraceLine™.
12. After at least 2 minutes, press FIRE TEST button and FAULT TEST button together until the display shows “EOL” (see Figure 11.4). TraceLine™ is acquiring the location parameter for the end of line.



Figure 11.4 – Location parameter for the end of the line

13. Place 1 m of line at end of cable into portable heat oven until the display shows flashing “PA”.
14. Remove the cable from the portable heat oven.
15. The calibration is end. This set location type LHD can be installed or launched into normal running.

12 LDS V2.0 Setting and Debugging Software

12.1 Introduction

LDS 2.0 configuration and commissioning software performs parameters setting and testing of the detector. The software comes in both Windows® and Windows CE® versions. The main features for both versions are identical. Connect with the detector through the RS 232 serial port of the computer.

The software is user friendly and does not create any registry in the computer operating system. Simply copying it to any disk will allow it to run.

Compatible Windows® versions are Windows 2000®, Windows 2000 Server®, Windows XP®, and Windows 2003 Server®. Windows 98® is not supported.

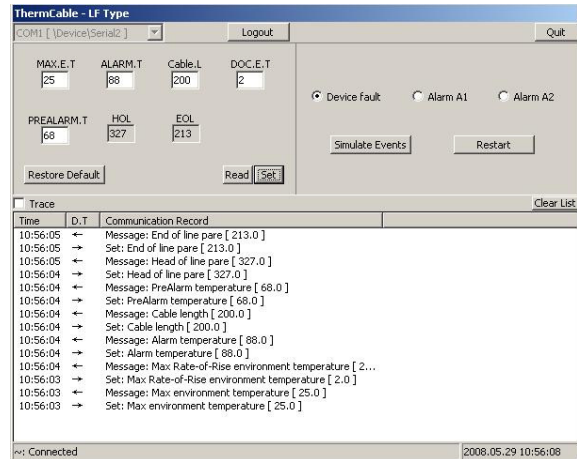

The Windows CE® version is compatible with Pocket PC 2003 or higher operating system.

12.2 Operating Procedure (Windows® Version)

12.2.1 Software Interface

12.2.1.1 Title Bar



Running the software displays the uppermost Title bar, as shown above. The software performs an identification test on the linear heat detector connected and then displays the known detector type, e.g. ThermoCable LFR type as shown below.



12.2.1.2 COM Port Pull-Down Menu

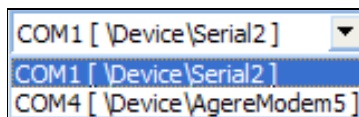

Below the Title bar is the COM Port Pull-Down Menu. The software self-checks during initiation and list all COM ports available for use in this pull-down menu.

12.2.1.3 Connect Button

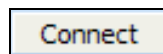

On the left of the COM Port Pull-Down Menu is the Connect button. After selecting the COM port, click on the Connect button for the software to start communicating with TraceLine™ through the selected port.

Note: The button will be hidden after being pressed. At the same time COM Port Pull-Down Menu will be

grayed out (as shown below).

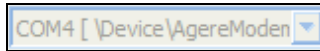

To safe guard the software and the detector during operation, changing of the COM port is not permitted once selected. If COM port needs to be changed, terminate the program and re-initiate the software.

12.2.1.4 Login Button

When running the software for the first time, no connection is established with COM port of detector, hence the Login button is inactive.



Only after the COM port is selected, the Connect button activated, and communication with TraceLine™ established, will the software then display the successful connection at the bottom Status bar:

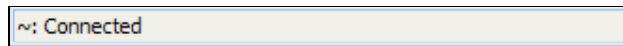

At this time, the Login button will be active.

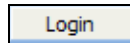

Clicking on the Login button, will initiate a self-check process to identify the TraceLine™ type. If the detector is of the preset type and successfully identified, the information will be display in the Title bar and the Login button changes to the Logout button.

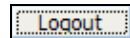

The software will also change to a Control window (see below).

12.2.1.5 Quit button

Click the Quit button to terminate the software operation.



12.2.1.6 Status Bar

The Status bar indicates:

- The connection status of the currently connected TraceLine™

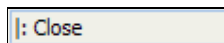

- Whether the COM port is not activated

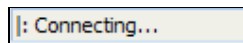

- Connection closure. The process of establishing connection with TraceLine™.
- Indicates successful connection with the Linear Heat Detector.

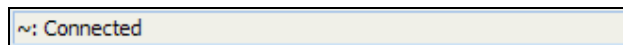

Note: However, there is one exception, a false connection may occur for computers installed with some special Modem (see FAQ No 2).

12.2.2 Control window

12.2.2.1 Line Type Heat Detector Control window

The self-check feature of the software is able to identify all five types of TraceLine™. For different

detectors inherent parameter settings, the software relies on selecting the appropriate control window for display.

The five different control windows are shown as below.

MAX.E.T	ALARM.T	Cable.L
25	88	200
DOC.E.T	PREALARM.T	
2	68	
Restore Default		Read Set

Figure 12.1 – Fixed temperature type control window

MAX.E.T	DOC.E.T	Cable.L	ALARM.T
25	2	200	88
ROR.T.LV:	<input checked="" type="radio"/> 1st	<input type="radio"/> 2ed	<input type="radio"/> 3rd
Restore Default		Read Set	

Figure 12.2 – Fixed temperature and rate-of-rise type control window

MAX.E.T	DOC.E.T	Cable.L	
25	2	200	
ROR.T.LV:	<input checked="" type="radio"/> 1st	<input type="radio"/> 2ed	<input type="radio"/> 3rd
Restore Default		Read Set	

Figure 12.3 – Rate-of-rise type control window

MAX.E.T	ALARM.T	Cable.L	DOC.E.T
25	88	200	2
PREALARM.T	HOL	EOL	
68	327	213	
Restore Default		Read Set	

Figure 12.4 – Location and fixed temperature type control window

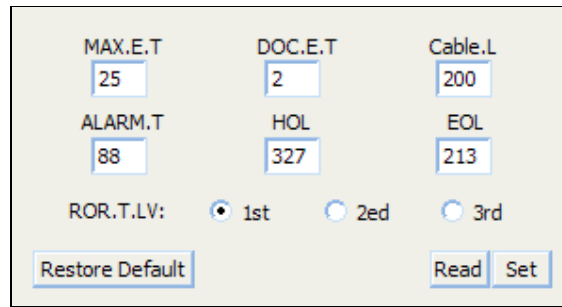
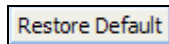

Figure 12.5 – Location, fixed temperature and rate-of-rise type control window

12.2.2.2 Common Controls for all Control Windows



When the Restore Default button is clicked, a command is sent to restore all parameter settings to the default values at factory output. Upon successful restoration, a message will be display in the message log and all the parameters will revert to display the default values.



When the Read button is pressed, a command is sent to retrieve the last set parameter settings. Successfully retrieved values will be displayed in the Control window and the operation will be registered in the message log.



Clicking the Set button saves the current parameter values in the Control window. Successful Set operation will be registered in the message log. If any of the parameter value is set out of the allowable range, the settings will not be saved and an error message and instructions will be displayed in the message log.

12.2.2.3 Glossary for Parameter Setting

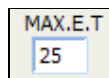

MAX.E.T denotes the maximum environmental temperature. This option sets the working environmental temperature of TraceLine™. Measurement unit is degrees Celcius and acceptable range of setting should be within -20 °C and +80 °C.

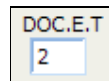

DOC.E.T denotes maximum rate-of-rise environmental temperature. This option sets the allowable rate of temperature rise for the working environment of TraceLine™. Measurement unit is degrees Celcius and the acceptable range of should be within 0 °C to 2 °C.

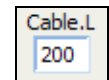

Cable.L denotes cable length. This option sets length of the conductive cable connected between the COM port and TraceLine™. Measurement unit is metres and the acceptable setting range should be from 50 m to 400 m.

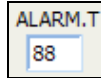

ALARM.T denotes the alarm temperature. This option sets the alarm triggering temperature for the F type TraceLine™. Acceptable setting range should be from +68 °C to +138 °C.

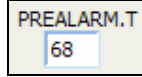

PREALARM.T denotes pre-alarm temperature. This option sets the pre-alarm triggering temperature for the F type TraceLine™. Measurement unit is degrees Celcius and the acceptable setting range is from +68 °C to +138 °C.

Note: PREALARM.T parameter value must be less than ALARM.T.

12.2.2.4 Glossary of parameter setting for Location type Linear Heat Detector

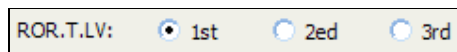

ROR.T.LV denotes rate-of-rise temperature level. This option sets the alarm triggering sensitivity level on differential temperature for the L type TraceLine™. There are three levels of sensitivity settings available.



HOL denotes head of line parameter that can be acquired by the temperature box test. HOL is one parameter set to compute the position of the overheating point. Acceptable setting range should be from 100~1000.



EOL denotes the end-of-line parameter that can be acquired by the temperature box test. EOL is one parameter set to compute the position of the overheating point. Acceptable setting range should be from 100~1000.

12.2.2.5 Events Simulation window

The event simulation window performs simulations to test for device fault and alarm functions.

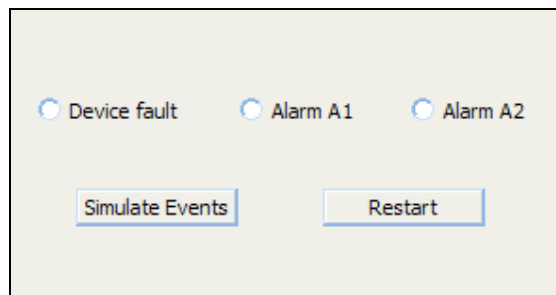
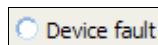

Figure 12.6 – Event simulation window



Activating the Device fault button simulates a TraceLine™ fault event.



Activating the Alarm A1 button simulates a TraceLine™ A1 event.



Activating the Alarm A2 button simulates a TraceLine™ A2 event.

The definition for alarm functions A1 and A2 differs for different linear heat detectors.

- For F Type detector, Alarm A1 means pre-alarm; Alarm A2 means fire alarm.
- For FR Type detector, Alarm A1 means rate-of-rise temperature alarm; Alarm A2 means fixed temperature alarm.
- For R Type detector, Alarm A1 is not used; Alarm A2 means rate-of-rise temperature alarm.
- For LF Type detector, Alarm A1 means pre-alarm; Alarm A2 means fire alarm.
- For LFR Type detector, Alarm A1 means rate-of-rise temperature alarm; Alarm A2 means fixed temperature fire alarm.

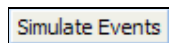

Select the event for simulation then activate by pressing the Simulate Events button. The software will send appropriate preset signals corresponding to the options selected to the TraceLine™. Successful simulation will trigger the associated indicators on TraceLine™.

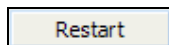

Once the event is simulated, there is no other means to terminate it other than clicking on the Restart button to restart the software. After pressing Restart, the software will logout from the control window, therefore the user must login again to gain access to the control window.

12.3 FAQ (Windows® Version)

12.3.1 COM Port Pull-Down menu does not display any available port.

Some Notebook computers do not have any COM ports. In this case, it is necessary to equip the computer with USB to RS 232 connector or other appropriate COM converters.

12.3.2 With status bar shows connected  and Login button is active state, but the software is unable to get passed the self-check identification process.

During product testing, it was found that some types of special modems may appear to the computer as a COM port facility. These modems send handshake signals to the software, creating a false signal for successful connection. Because there is no physical connection with TraceLine™, the identification self-check fails. If it is unsure which COM port in the menu is a physical port. Checking on the path name may be a good approach.

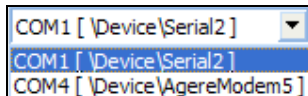

For example, the registered path name for COM1 is \\Device\\Serial2 while for COM4 is \\Device\\AgereModem5. This means that it is almost certain that COM1 is a physical port, while COM4 is the modem installed.

However, if all the COM ports in menu fail to identify the TraceLine™, contact Zeta Alarm System for other technical options.

13 Ordering Information

Description		Order Number
Sensor Cable		
NBC800/F fixed temperature alarm	High temperature PVC sensor cable Red colour, 600 m (1968 ft) coil	92-0816-001
NBC800/R rate-of-rise heat alarm	High temperature PVC sensor cable Yellow colour, 600 m (1968 ft) coil	92-0816-002
NBC800/FR fixed temperature and rate-of-rise heat alarm	High temperature PVC sensor cable Blue colour, 600 m (1968 ft) coil	92-0816-003
NBC800/F/NC fixed temperature alarm	Polytetrafluoroethylene sensor cable Orange colour, 600 m (1968 ft) coil	92-0816-004
NBC800/R/NC fixed temperature alarm	Polytetrafluoroethylene sensor cable Orange colour, 600 m (1968 ft) coil	92-0816-005
NBC800/FR/NC fixed temperature alarm	Polytetrafluoroethylene sensor cable Green colour, 600 m (1968 ft) coil	92-0816-006
NBC800/F/BB fixed temperature alarm	Bronze braided cable Red PVC and braid, 600 m (1968 ft) coil	92-0816-007
NBC800/R/BB rate-of-rise heat alarm	Bronze braided cable Yellow PVC and braid, 600 m (1968 ft) coil	92-0816-008
NBC800/FR/BB fixed temperature and rate-of-rise heat alarm	Bronze braided cable Blue PVC and braid, 600 m (1968 ft) coil	92-0816-009
NBC800/L/F Location type fixed temperature alarm	standard PVC sensor cable Red colour, 600 m (1968 ft) coil	92-0816-010
NBC800/L/FR Location type fixed temperature and rate-of-rise heat alarm	standard PVC sensor cable Blue colour, 600 m (1968 ft) coil	92-0816-011
NBC800/L/F/NC Location type fixed temperature alarm	polytetrafluoroethylene sensor cable, Orange colour, 600 m (1968 ft) coil	92-0816-012
NBC800/L/FR/NC Location type fixed temperature and rate-of-rise heat alarm	polytetrafluoroethylene sensor cable Green colour, 600 m (1968 ft) coil	92-0816-013
NBC800/L/F/BB Location type fixed temperature alarm	bronze braided sensor cable Red PVC and braid, 600 m (1968 ft) coil	92-0816-014
NBC800/L/FR/BB Location type fixed temperature and rate-of-rise heat alarm	bronze braided sensor cable Blue PVC and braid, 600 m (1968 ft) coil	92-0816-015
Monitor and control units		
NBM800/F fixed temperature alarm	Monitor control unit	92-0816-016
NBM800/R rate-of-rise heat alarm	Monitor control unit	92-0816-017
NBM800/FR fixed temperature and rate-of-rise heat alarm	Monitor control unit	92-0816-018
NBM800/L/F fixed temperature alarm	Location type monitor control unit	92-0816-019
NBM800/L/FR fixed temperature and rate-of-rise heat alarm	Location type monitor control unit	92-0816-020
Boxes		
JB92198	Standard junction box	92-0816-021
JB92198EX	Explosion-proof junction box	92-0816-022
EOL92198	Standard end-of-line box	92-0816-023
EOL92198EX	Explosion-proof end-of-line box	92-0816-024
Accessories		

Zeta Alarm System.

Self-Adaptive Compensation Line Type Heat Detector

Description	Order Number
LDS V2.0 LHD parameter setting and debugging software	92-0816-025
Edge clip	92-0816-026
Knock-on clip	92-0816-027
Thermal spacer	92-0816-028
V-type clip	92-0816-029
T-type clip	92-0816-030
L bracket	92-0816-031
Nylon cable tie (pkg. 100) for pipe up to 200 mm	92-0816-032