

# Premier sx

FIRE ALARM CONTROL PANEL

## INSTALLATION MANUAL

## CONTENTS

1.	INTRODUCTION.....	3
1.1	HANDLING THE PCBS	
1.2	USING THIS MANUAL	
1.3	ABOUT THE PREMIER SX FACP & INTEGRAL PSE	
1.4	DESIGNING THE SYSTEM	
1.5	EQUIPMENT GUARANTEE	
2.	FIRST FIX GUIDELINES.....	4
2.1	RECOMMENDED CABLE TYPES AND THEIR LIMITATIONS	
2.2	MAINS WIRING RECOMMENDATIONS	
2.3	DETECTOR CIRCUIT WIRING DIAGRAM	
2.4	SOUNDER CIRCUIT WIRING DIAGRAM	
2.5	AUXILIARY INPUT WIRING EXAMPLES	
2.6	AUXILIARY OUTPUT WIRING (VOLTAGE FREE CHANGE OVER CONTACTS)	
3.	MOUNTING THE FIRE ALARM PANEL.....	7
3.1	PLANNING CABLE ENTRY	
3.2	FIXING THE BACKBOX TO THE WALL	
4.	CONNECTING MAINS & BATTERY POWER.....	8
4.1	CONNECTING MAINS POWER	
4.2	CONNECTING THE BATTERIES	
5.	FIELD DEVICE TERMINATION.....	9
5.1	TERMINATING THE DETECTION AND ALARM (SOUNDER) CIRCUITS	
5.2	AUXILIARY INPUT AND OUTPUT TERMINATIONS	
6.	SOUNDER ACTIVATION DELAY.....	10
6.1	DECIDING TO USE A DELAY	
6.2	TO SET A DELAY	
6.3	DELAY INDICATION AND OVERRIDE	
7.	ZONE DISABLEMENT.....	10
7.1	WHY USE ZONE DISABLEMENT	
7.2	TO PROGRAM A ZONE (OR SOUNDERS) AS DISABLED	
8.	ZONE TEST.....	11
8.1	WHY USE ZONE TEST	
8.2	TO PROGRAM ZONE IN TEST	
9.	GENERAL FAULT FINDING.....	12
9.1	ZONE FAULTS	
9.2	SYSTEM FAULT	
9.3	SUPPLY FAULTS	
9.4	EARTH FAULTS	
9.5	SOUNDER FAULTS	
10.	STANDBY BATTERY CALCULATION GUIDE.....	13
11.	PCB TERMINATION CONNECTIONS.....	14
11.1	CONNECTIONS	
11.2	FUSES	
12.	CONTROL PANEL ELECTRICAL SPECIFICATIONS.....	15
12.1	ENCLOSURE SPECIFICATIONS	
12.2	ELECTRICAL SPECIFICATIONS	

## 1.INTRODUCTION

### **THIS FIRE ALARM CONTROL PANEL IS CLASS 1 EQUIPMENT AND MUST BE EARTHED**

**This equipment must be installed and maintained by a qualified and technically experienced person.**

#### 1.1 HANDLING THE PCBs

**If the PCBs are to be removed to ease fitting the enclosure and cables, care must be taken to avoid damage by static.**

The best method is to wear an earth strap, but touching any earth point (eg building plumbing) will help to discharge any static. Hold PCBs by their sides, avoiding contact with any components. Always handle PCBs by their sides and avoid touching the legs of any components. Keep the PCBs away from damp dirty areas, e.g. in a small cardboard box.

#### 1.2 USING THIS MANUAL

This manual explains, in a step-by-step manner, the procedure for the installation of the **Premier SX** Range of Fire Alarm Control Panels. For full operational and maintenance information, please refer to document GLT.MAN-102 (USER MANUAL, MAINTENANCE GUIDE & LOG BOOK). It also contains a System set-up table, and Installation Certificate, that must be completed by the Commissioning Engineer prior to system handover.

**Unlike the User Manual, this Installation Manual must not be left accessible to the User.**

#### 1.3 ABOUT THE PREMIER SX FIRE ALARM CONTROL PANEL & INTEGRAL PSE

- The PREMIER SX Fire alarm control panel is available in 1,2,4,6 or 8 Zone sizes.
- It has 2 sounder output circuits each capable of supplying 400mA.
- It has a set of fire relay contacts (voltage free) rated at 1A SELV.
- It has a set of fault relay contacts (voltage free) rated at 1A SELV. This relay is normally powered to allow a fault output in the case of total power failure.
- It has a class change connection to allow remote activation of the sounders. (not required by EN54-2)
- It has the ability to disable any zone or the sounder circuits.
- It has a one man test mode, which resets the zone in test after 7 seconds.(EN54 option with requirements)
- It has a sounder delay facility (0-9 minutes in 1 minute steps). (EN54 option with requirements)
- It has a maximum battery capacity of 7 Ah.

- It has an in built capability of operating with Diode bases (for line continuity on head removal).
- It will operate in ambient temperatures of -5 to 40°C
- It will operate in a relative humidity of up to 93% (non condensing)
- It will withstand vibrations between 5 & 150 Hz
- It has a maximum capacity of 32 devices per zone
- The PSE is linear, with a 1.1A output at system voltage (18-32V)
- The mains supply is filtered before entering the transformer.
- The charger & battery are both fused at 1.6A (Quickblow)
- The PSE will draw a maximum of 25uA from the battery in the event of mains failure. (the FACP will continue to take around 60mA)
- The FACP & PSE should be maintained as described in section 3 of the User Manual, Maintenance Guide & Log Book.

#### 1.4 DESIGNING THE SYSTEM

This manual is not designed to teach Fire Alarm System design. It is assumed that the installer has an understanding of Fire Alarm System components and their use.

We strongly recommend consultation with a suitably qualified, competent person regarding the design of the Fire Alarm System. The System must be commissioned and serviced in accordance with our instructions and the relevant National Standards. Contact the Fire Officer concerned with the property at an early stage in case he has any special requirements.

If in doubt, read BS 5839: Pt 1: 2002 "Fire Detection and Fire Alarm Systems for buildings (Code of Practice for System Design, Installation, Commissioning and Maintenance)" available from the BSI, or at your local reference library.

#### 1.5 EQUIPMENT GUARANTEE

If this equipment is not fitted and commissioned according to our guidelines, and the relevant National Standards, by an approved and competent person or organisation, the warrantee may become void.

## 2. FIRST FIX

**All wiring must be installed to meet BS5839: Pt1: 2002 and BS 7671 (Wiring Regs) standards. Other National standards of fire alarm system installation should be adhered to where applicable.**

### 2.1 RECOMMENDED CABLE TYPES AND THEIR LIMITATIONS

Screened cables should be used throughout the installation to help shield the Panel from outside interference and ensure EMC compatibility.

The two categories of cable according to BS5839: Pt1: 2002, Clause 26 "Fire Detection and Alarm Systems for Buildings (Code of Practice for System Design, Installation and Servicing)" are:

**Standard fire resisting cable – to PH30 classification of EN 50200**

**Enhanced fire resisting cable – to PH120 classification of EN 50200**

**(Note that all cables should be at least 1mm<sup>2</sup> cross section)**

On the Optima Panel the general recommendation would be to use standard fire resistant cable, such as Firetuff™, FP200 or an equivalent. These cables are screened, and will provide good ECM shielding when properly grounded at the panel. Certain system specifications may demand the use of a particular type of cable and due regard should be paid to this fact.

Depending on the environment, the cables may need mechanical protection (such as a conduit).

### 2.2 MAINS WIRING RECOMMENDATIONS

The Mains supply to the FACP is fixed wiring, using **Fire resisting** 3-core cable (Between 1 mm<sup>2</sup> and 2.5mm<sup>2</sup>) or a suitable 3-conductor system, fed from an isolating double pole switch fused spur, fused at 3A. **IT SHOULD NOT BE CONNECTED THROUGH AN RCD.** This should be secure from unauthorised operation and be marked 'FIRE ALARM: DO NOT SWITCH OFF'. The supply must be exclusive to the Fire Panel. **MAKE SURE ANY SPARE ENTRY HOLES ARE COVERED WITH THE GROMMETS PROVIDED**

For information on how to connect Mains to the Panel's Power Supply PCB, see page 8. Also refer to rating information inside the FACP.

### 2.3 DETECTOR CIRCUIT WIRING DIAGRAM

The Premier SX comes with one, two, four, six or eight Detection circuits (Zones). A maximum of 32 devices (i.e. smoke detectors, heat detectors, or Manual Call Points) can be fitted to each circuit. **ALL DEVICES MUST BE POLARISED.**

*Typical detector circuit wiring (Premier Detectors)*

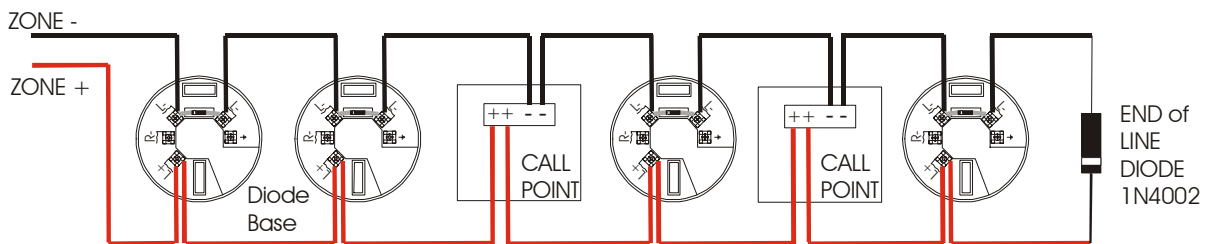

Do not spur devices because they will not be monitored

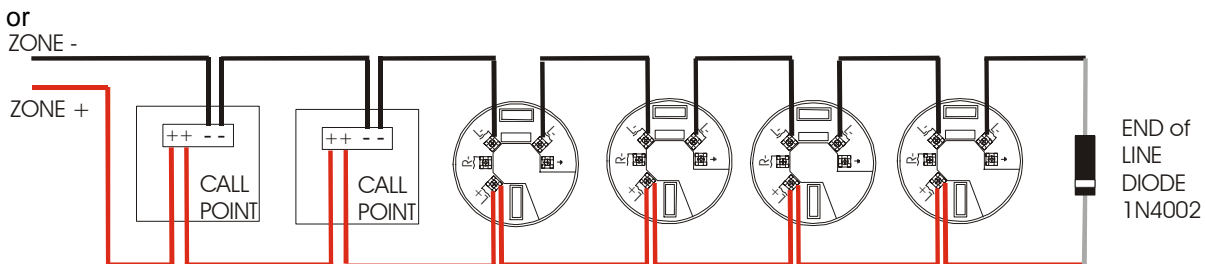

If ALL the call points are connected to the start of the zone, then conventional bases can be used instead of diode bases.

An End of Line diode (provided in the Panel) must be connected across the terminals of the last device on each circuit to allow the wiring to be monitored. It is polarity sensitive, and connected cathode (STRIPE) to +ve

Using detector bases with continuity diodes fitted will allow all devices, including Manual Call Points to remain operational if a detector is removed from its base.

Old Manual call points, which just cause a short circuit, are not directly compatible, as they would cause a short circuit fault. Fitting a 470R resistor in line with the call point will allow it to work. (Wired in a similar way to non-polarised bells shown at the foot of this page).

Other makes of detector will have different connections, but in general they are wired **+IN & + OUT** to same terminal, **- IN** to stripe side of continuity diode, **-OUT** to non-stripe side of continuity diode. Some makes will connect the +ve to a 470R load resistor, or a polarisation diode, to enable the detector to work correctly.

Our new Fyreye detectors (pronounced "fire-eye") will split the +ve line instead. These will be wired as shown below

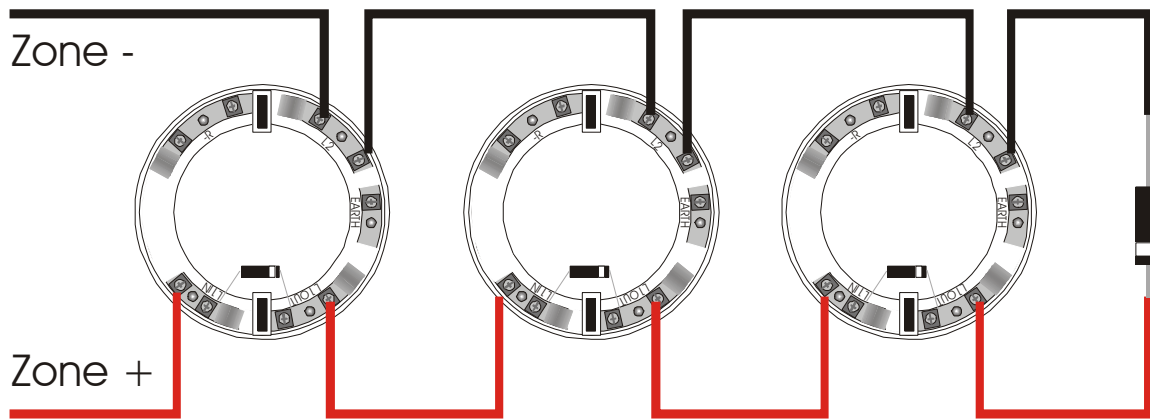

The termination of each detection circuit must be as indicated on the main PCB (See page 15). The Earthing of the cable screens should be as shown on page 9.

**2.4 SOUNDER CIRCUIT WIRING DIAGRAM**

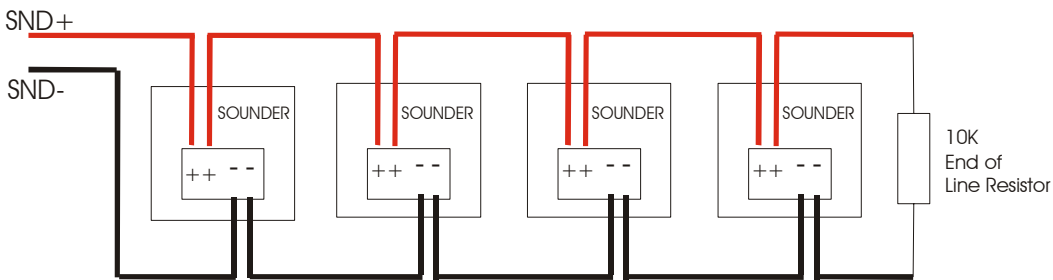

Note: If non-polarised alarm devices (eg some types of old mechanical bell, or a relay) are used, then a diode will have to be placed in line with the device to enable fault monitoring. They may also need a back EMF protection diode. (symptoms: Chattering sounder relays that don't turn off).

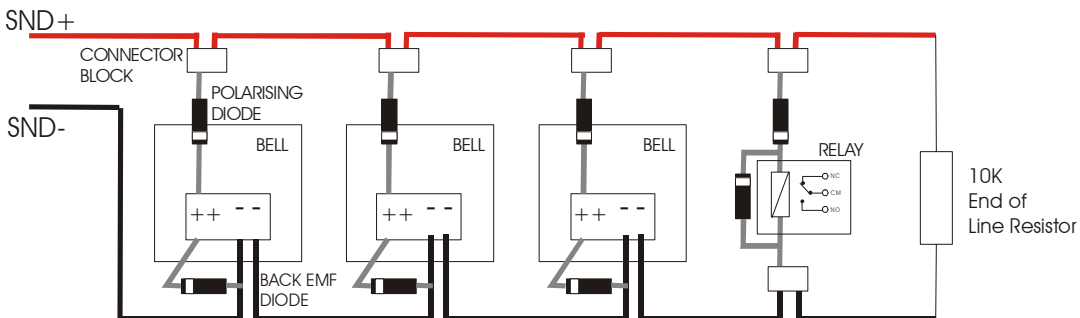

## 2.5 AUXILIARY INPUT WIRING EXAMPLES

There is one non-latching auxiliary input connection on the Fire Alarm Panel.

**Class Change Input (CC):** This Will energise all alarm continuously when the CC terminals are shorted together. If the class change is triggered, the fire auxiliary relay output will not operate.

*Typical auxiliary input wiring options*

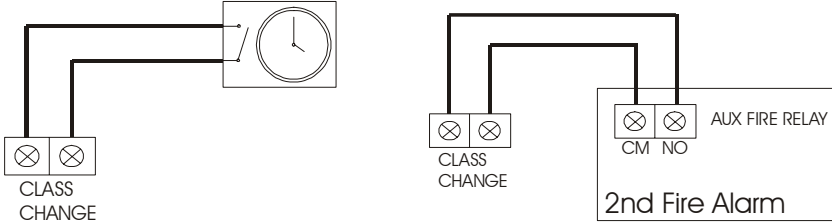

The termination for the above inputs must be as indicated on the main PCB (See page 15). The Earthing of the cable screens should be as shown on page 9.

## 2.6 AUXILIARY OUTPUT WIRING (VOLTAGE FREE CHANGEOVER CONTACTS)

**Auxiliary Fire Output (AUX):** Changes over in any fire condition, and be used for driving local fire fighting equipment such as sprinkler systems, magnetic door holders, air conditioning shut off, etc.

**Fault Output (FAULT):** This Output is energised in the quiescent condition. In a fault condition, the output relay turns off, to ensure failsafe operation even in the event of total power loss. That is, the normally open contact will be closed when there is no fault, and open when there is a fault. This should be taken into account when any device is connected to the fault relay.

*Typical auxiliary output wiring*

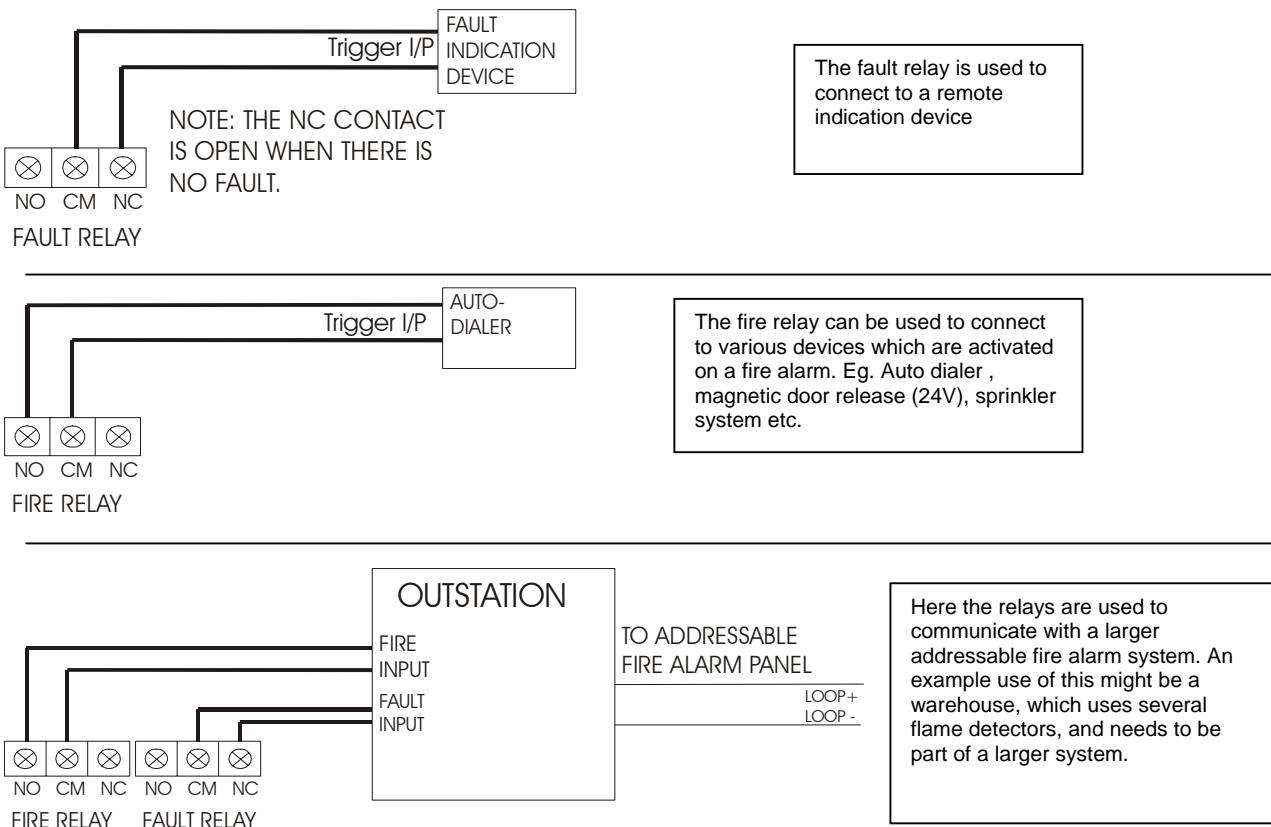

The termination for the above inputs must be as indicated on the main PCB (See page 15). The Earthing of the cable screens should be as shown on page 9.

### 3. MOUNTING THE FIRE ALARM PANEL

It is recommended that the panels door be removed to avoid accidental damage. Also, the termination PCB could be removed and stored in a safe place, while fixing the back box to the wall.

#### 3.1 PLANNING CABLE ENTRY

Fig.2 below shows the location of the cable entries to facilitate planning of wiring (home runs) to be brought to the panel.

The grommets can be easily removed by a push from inside the control panel box.

If a grommet is removed, fill the hole with a brass cable gland. If any knockout is removed, but subsequently not used, it should be covered up.

The 230Va.c. Mains cable must be fed into the enclosure via one of the cable entries at the top right corner of the back box. (Refer to "Connecting the Mains" on Page 8).

#### 3.2 FIXING THE BACK BOX TO THE WALL

Figure 2: Plan view inside the enclosure without PCBs. Side view for surface / flush installation.

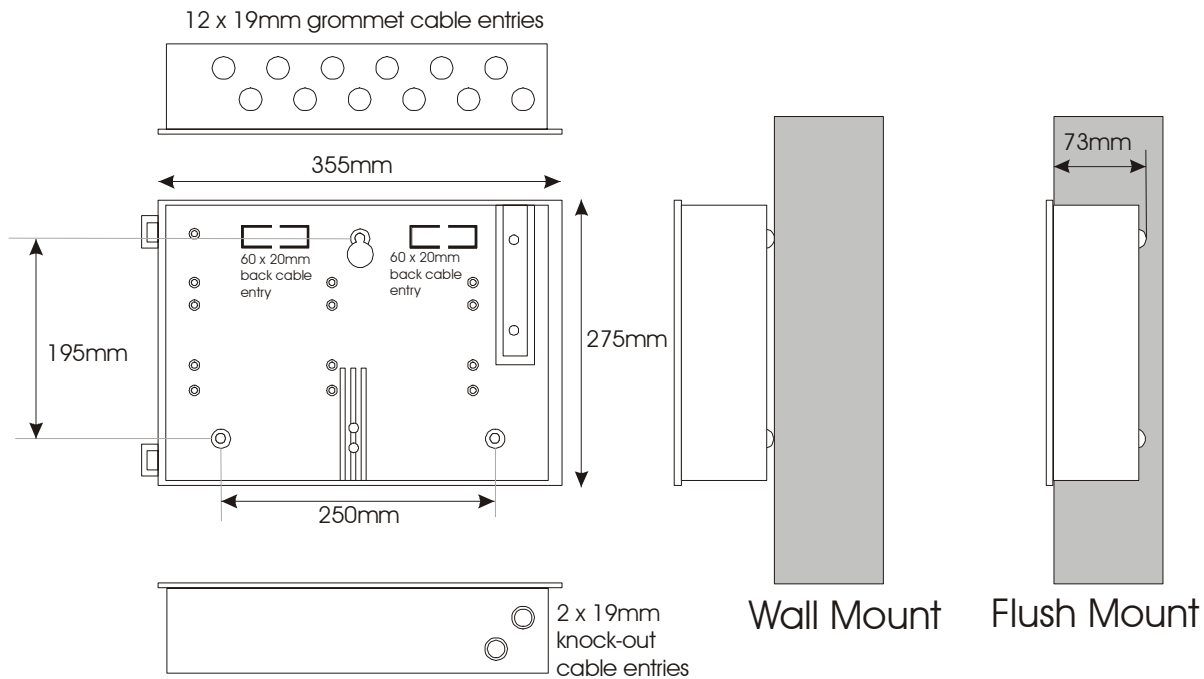

Fix the enclosure to the wall using the three mounting holes provided.

Check the build & condition of the wall to decide a suitable screw fixing.

The mounting holes are designed for No 8 roundhead or countersunk woodscrews (or similar).

Remove any debris from the enclosure.

Take care not to damage the FACP during installation.

## 4 CONNECTING MAINS & BATTERY POWER

### 4.1 CONNECTING THE MAINS POWER

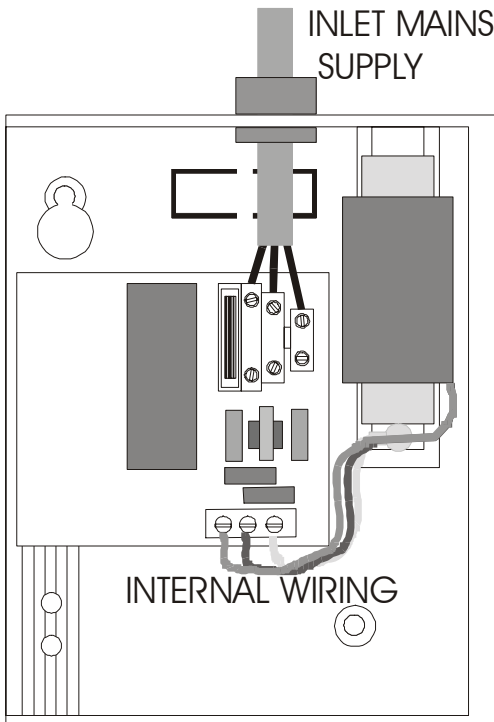

Figure 3: Power Supply PCB layout and Mains connection details

The panel should be connected to 220-240V AC by a 3A rated spur to the fuse box with 1.0mm<sup>2</sup> to 2.5mm<sup>2</sup> 3-core cable. Nothing else should be connected to this supply

The Live, Earth and Neutral connections are marked on the PCB. The Mains is protected by a quick blow 20mm 2A HBC fuse. (Also known as HRC)

The incoming mains cable should be kept separate from the zone cables to help minimise mains interference.

Once the mains is connected, the protective cover should be replaced BEFORE turning on the mains power. This will minimise the chance of electric shock from the PCB.

**MAKE SURE ANY SPARE ENTRY HOLES ARE COVERED WITH THE PLASTIC GROMMETS PROVIDED**

It is advisable to apply power to the panel before connecting any devices, to check for correct operation, and to familiarise yourself with the fire alarm panels controls.

### 4.2 CONNECTING THE BATTERIES

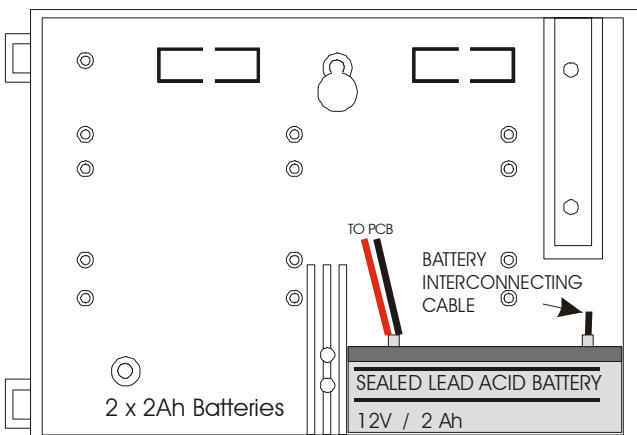
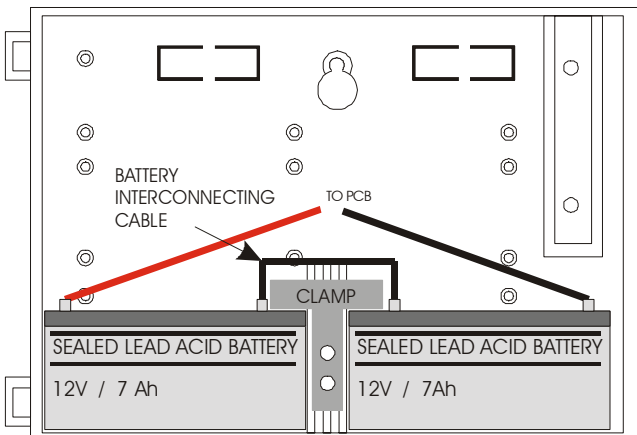

Figure 4: Battery location and connection details

Although there are many sizes of suitable battery, the sizes we usually recommend are 12V 7Ah, or 12V 2Ah, and the enclosure has been designed to hold these two sizes.

To calculate the exact requirement, use the equation in section 10, but as a rough guide:-

2/4 Zones, 24 Hr standby – 2Ah

2/4 Zones, 48 Hr+ standby – 7Ah

6/8 Zones – 7Ah

#### BATTERY CONNECTIONS

The two batteries are wired in **series**.

The **+ve** of one battery is connected to the **red** battery lead.

The **-ve** of the other battery is connected to the **black** battery lead.

The **-ve** of the first battery is connected to the **+ve** of the second battery using the link wire supplied.

**When fitting the batteries, take care not to damage the temperature monitoring thermistors. See figure 4a overleaf.**



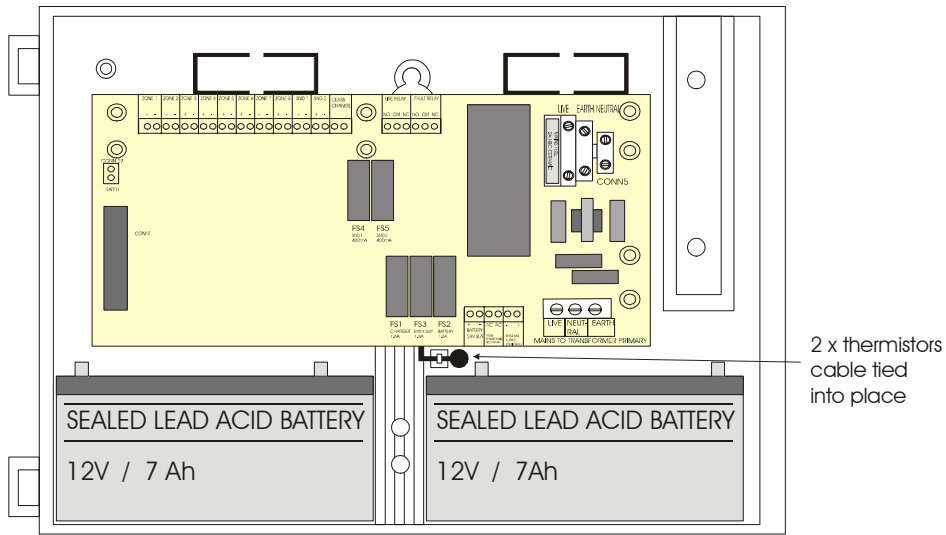

Figure 4a: Thermistor location

These thermistors are used to prevent overcharging the batteries in high ambient temperatures.

## 5. FIELD DEVICE TERMINATION

### 5.1 TERMINATING THE DETECTION AND ALARM (SOUNDER) CIRCUITS.

All cables entering the enclosure should have brass cable glands, which will ensure a good ground to the steel EMC cable grounding plate. The Detector and Sounder circuits should be connected to the appropriate connector block on the Termination PCB as shown in Figure 6 below. All screens should be fed through the gland to make electrical contact with it, and be terminated at the brass earthing strip as shown below (see Figure 6 & 6a)

(For detailed detector and alarm circuit wiring diagrams, please refer to pages 4 and 5.)

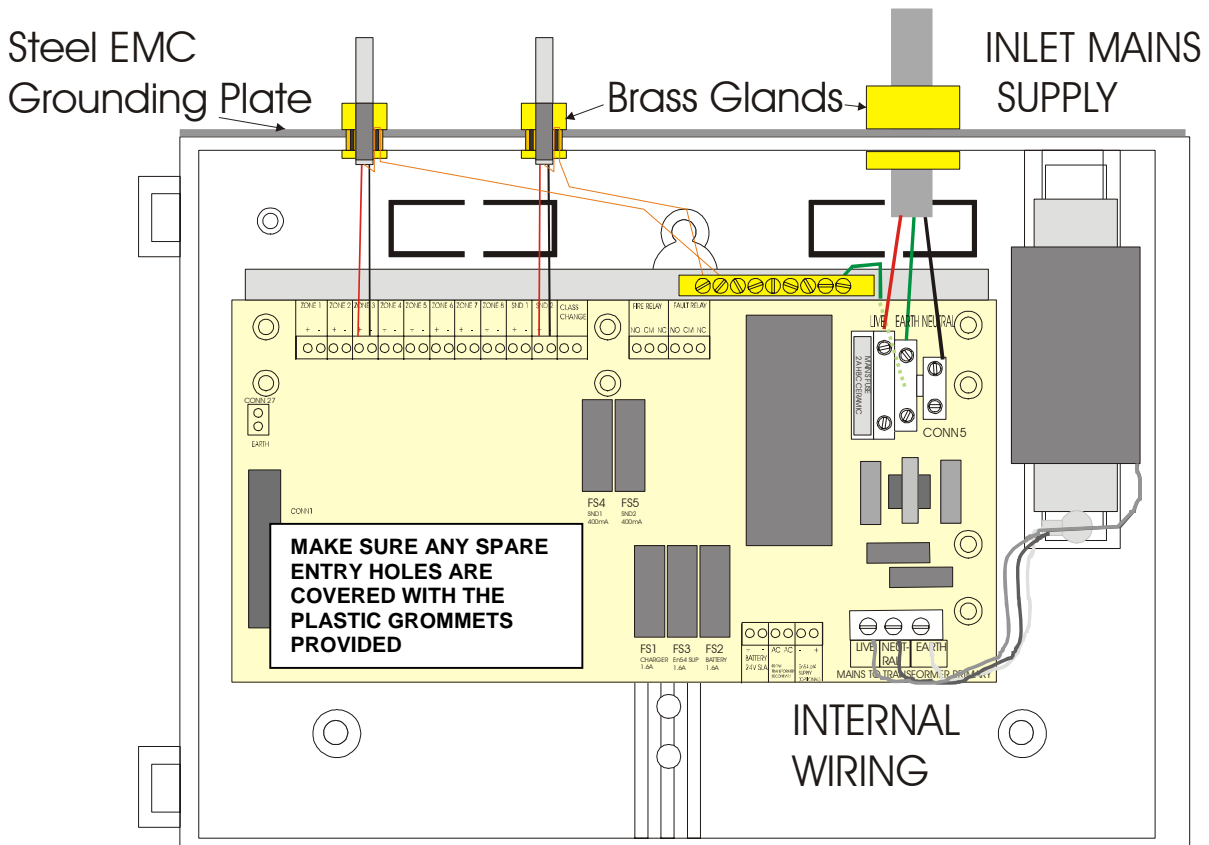

Figure 6: Detector and Sounder Circuit Connection

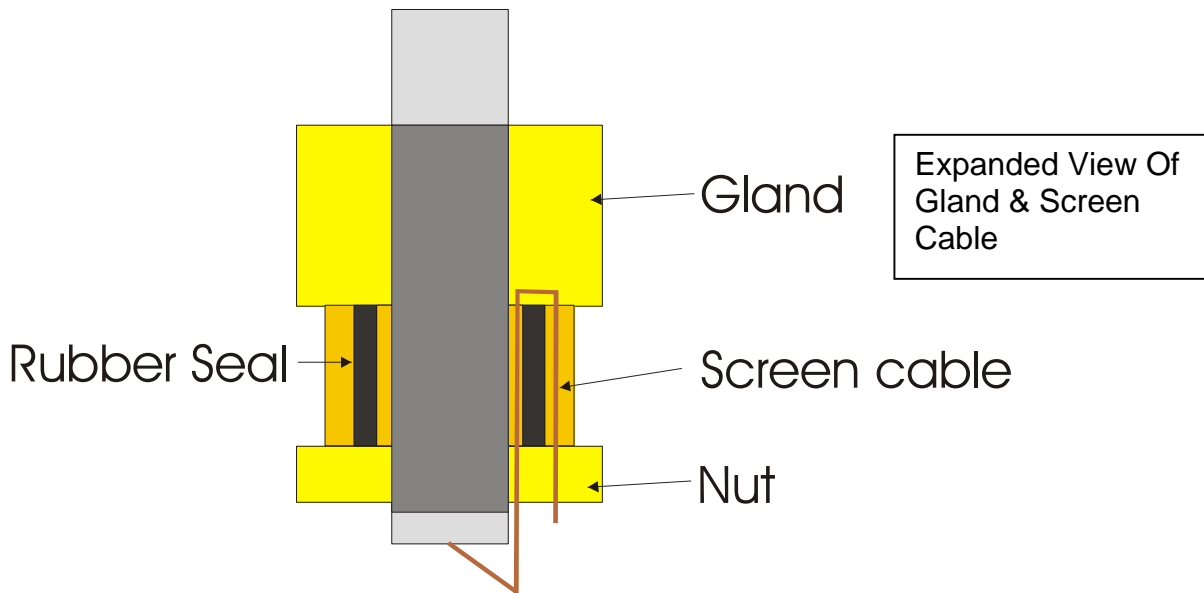

Figure 6a: Expanded view of brass cable gland.

**5.2 AUXILIARY INPUT AND OUTPUT TERMINATIONS**

Connect auxiliary input and output cables to the appropriate connector block terminals on the Termination PCB (See Page 15). Screened cables should be terminated as per figure 6.

For a full description of the inputs and outputs available on the Premier SX range of Fire Panels, including typical wiring diagrams please refer to pages 5 & 6.

**6. SOUNDER ACTIVATION DELAY**

**6.1 DECIDING TO USE A DELAY**

A delay of up to nine minutes from the Fire Alarm Panel being triggered, to its Alarm sounder outputs being activated, can be programmed into the panel by the Engineer. This is a particularly useful feature for schools, nightclubs and other public places where the nuisance and panic caused by a false alarm must be avoided. It should be noted that the delay period will apply to ALL zones.

When an Alarm occurs on any zone, it is processed as normal. However, the activation of the sounders is postponed until the delay period has expired, thus allowing the cause of the Alarm to be investigated by the User. If the alarm is false the alarm can be cancelled.

**6.2 TO SET A DELAY**

Open the panel door using Alan Key provided and set switch 7 (**SW7**) using a terminal screw driver to the delay required

SW7 Setting	External sounder delay in minutes
0	No delay
1	1 minute
2	2 minutes
3	3 minutes
4	4 minutes
5	5 minutes
6	6 minutes
7	7 minutes
8	8 minutes
9	9 minutes

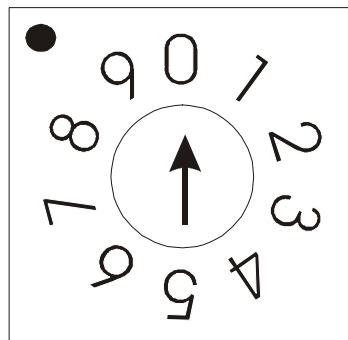

### 6.3 DELAY INDICATION AND OVERRIDE

If a delay is set, the fire panel will light the General Disablement LED and Delay (DEL) LED to indicate that the sounders are delayed. If an alarm occurs, the fire LEDs will light as usual, but the sounders will not start until the delay period has expired. After the delay period, the Gen Disablement and Delay LEDs will extinguish & the sounders will start.

Pressing the 'sounder override' switch will override the delay at any time and results in the sounders being turned on immediately.

If on investigation, the panel was activated by a false alarm, turn the keyswitch to Controls Enabled, and press the reset button. This will return the system to normal, without the sounders being activated. (Assuming the cause of the false alarm has been removed).

The delay can be removed by either returning the rotary switch to position 0, or by turning keyswitch to Controls Active, pressing Engineer, then pressing Delay override. (Continuing to press delay override will toggle the delay on & off).

## 7. ZONE DISABLEMENT

### 7.1 WHY USE ZONE DISABLEMENT

To aid commissioning and assist routine maintenance checks, any of the zones or the sounder circuits can be disabled.

When a zone (or sounder cct) is disabled, the panel will not respond to any fault or fire signals it receives from that zone. This might be used if the system requires routine maintenance, and the customer needs the system to continue running, but doesn't want spurious false alarms.

The panel will respond in the usual manner to any events in any non-disabled zones.

### 7.2 TO PROGRAMME ZONE (OR SOUNDERS) AS DISABLED

Any number of zones (or the sounders) can be disabled, but it is good practice to only disable one zone at a time.

1. Insert and turn control key to enabled position;
2. Press Engineer switch and the GENERAL DISABLEMENT LED will come on (flashing fast);
3. Press Scroll switch and the GENERAL DISABLEMENT LED will flash slowly. The panel is now in SELECT DISABLEMENT MODE.
4. Press scroll button again. Zone 1 DISABLEMENT LED will be lit. Continue to press scroll until the desired Zone or sounder is lit. Press the Engineer button. The GENERAL DISABLEMENT LED will be lit constantly indicating that this zone (or sounder) is now disabled.
5. If more than one zone needs to be disabled, then press scroll again until the required zone is selected.
6. If the panel needs to be taken out of SELECT DISABLEMENT MODE (eg to silence a fault on another part of the system), turn the keyswitch off, then back on again.
7. Once all the work has been done the zones need to be enabled again. If the panel is still in SELECT DISABLEMENT MODE, jump to paragraph 8, otherwise, turn the keyswitch to controls enabled, press engineer button (GENERAL DISABLEMENT LED will flash fast). Press scroll and it will return to being on steady. The panel is now in SELECT DISABLEMENT MODE
8. Press the scroll button until the disabled zone has been selected. Press engineer button. Scroll to any other disabled zone and enable in the same way. When all zones are enabled again, the GENERAL DISABLEMENT LED will flash slowly. Turn the keyswitch to off to return the system to normal.

## 8. ZONE TEST

### 8.1 WHY USE ZONE TEST

To aid commissioning and assist routine maintenance check, a non-latching 'one man test' facility is available.

When a detector or manual call point is triggered on any zone in Test, the Alarm sounders operate for approximately seven seconds on and seven seconds off. This cycle continues until the cause of the Alarm is removed (either by the test smoke clearing from the detector or the manual call point being reset), at which point, the detector circuit also automatically resets.

Should an Alarm occur on a zone that is not programmed to test, the Alarm will be processed in the normal way. The testing of the zone in test will temporarily be suspended until the Alarm(s) from the other zones are reset. At this point, zone retesting may resume.

### 8.2 TO PROGRAMME ZONE IN TEST

NOTE: Only **one zone** can be programmed in test at any one time.

1. Insert and turn control key to enabled position;
2. Press engineer switch until the General Zone test LED is on (flashing fast);
3. Enter Engineer Code 4114 and then the General Zone Test LED is on (flashing slow);
4. Press scroll switch and Zone one fault LED will flash in synchronisation with the General Zone test;
5. Press scroll button to the desired Zone for test. Once the desired Zone LED is flashing, this Zone is now in test mode.
6. Once testing of that zone is completed, press scroll button to move to another Zone or turn the control key switch to off position to exit test mode.

## 9. GENERAL FAULT FINDING

### 9.1 ZONE FAULTS

Open circuit faults will be indicated by zone(s) fault LED flashing. In case of a short circuit fault, then the Zone(s) Fault LED will be accompanied by the Short Circuit Fault LED. In both cases, the internal Fault Buzzer will sound and the General Fault LED will be lit.

The Zone Faults are non-latching faults. That is, if the fault disappears, the panel will automatically reset itself. (After a short delay of up to a minute)

#### Suggested Action

- a) Disconnect the wiring for the zone showing fault, and refit the end of line diode at that zone terminal in the panel. If the fault condition for that zone clears, this confirms there is a wiring fault.
- b) Double-check the wiring and the end of line diode on the zone. Trace the fault with consideration for the type of fault indicated.(HINT: splitting the cable half way down the zone, and fitting the end of line diode to the new end point helps to determine which section of cable is giving the fault)  
Note: A common fault is a detector head badly seated in a base that is not making the connection.
- c) A short circuit on a zone could be caused by the end of line diode being fitted backwards.
- d) Check that the detectors are compatible with this FACP. Note that some makes of detector will require a series resistor or diode to be fitted to work properly. There is usually a spare connector on the base to accommodate this (check instructions that came with the detector).
- e) Measure the resistance of the zone cabling (Remove from panel and short out end of line). Ideally this should be less than 50 ohms. Above 70 ohms may cause an open circuit fault.

## 9.2 SYSTEM FAULT

A system fault is an abnormal microprocessor running condition due to various unexpected phenomena

This will result in the panel attempting to correct itself. Should this fault occur, the System Fault LED, General Fault LED, General Fault relay and fault internal buzzer will be constantly active until the control keyswitch is turned from off position to control enable position. This should cause this fault condition to reset. If not, consult your supplier

## 9.3 SUPPLY FAULTS

A power supply fault is indicative of one or more of the following faults: -

### 1. Loss of Mains power – Remedy

- a. Check mains fuse (Conn 5). Also, check that main power is present.
- b. Check charger fuse FS1.

### 2. Loss of Battery power – Remedy

- a. Check battery fuse FS2.
- b. Check that battery connections are secure.

### 3. Low Battery – Remedy

- a. Check battery voltage.

### 4. Wrong Charging Voltage.

The charging voltage should be 28.4V off load at 20°C. If it has been altered, reset using potentiometer VR1

### 5. Overcharged Batteries.

Remove the batteries and measure the voltage. If it is reading over 27.4 then the batteries are overcharged. Try to run the panel on batteries only for half an hour or so to try to discharge the batteries. If this doesn't solve the problem, replacement batteries will be required.

## 9.4 EARTH FAULTS

An EARTH fault indicates that something is shorting to earth (usually through the cable screen). Disconnect the earth screens one at a time to determine the problem line.

(Note: connecting other equipment, eg an oscilloscope, to the panel can give an earth fault)

The voltage between battery –Ve and earth should be 14-16 volts. If it is not, the voltage should indicate what is shorting to earth.

## 9.5 SOUNDER FAULTS

Check that the correct END of Line resistor has been fitted. (10K – brown, black, orange, gold)

Check that both fuses are OK (FS4 & FS5 – 400mA QB)

If working on an existing installation, check that the devices are polarised. (See Page 5)

Check cable continuity (remove from panel and measure continuity. Should read 10K)

## 10. STANDBY BATTERY CALCULATION

In order to calculate the standby battery size required, the following formula can be used:-

$$\text{Battery Size (Standby time in Amp Hours)} = 1.25 \times [(T_{\text{ALM}} \times I_{\text{ALM}}) + (T_{\text{SBY}} \times (I_{\text{QP}} + I_{\text{QZ}}))]$$

Where:

- $T_{\text{ALM}}$  = Maximum time in hours required for the alarm [ $\frac{1}{2}$  hour is most common time]
- $I_{\text{ALM}}$  = Total Alarm Current in amps for all alarm devices connected to the alarm circuits
- $T_{\text{SBY}}$  = Standby time in hours for the system after mains failure [normally 24, 48 or 72 hr]
- $I_{\text{QP}}$  = Quiescent current in amps of control panel in fault condition [because of mains failure]
- $I_{\text{QZ}}$  = Quiescent current in amps of all detection zones. Eg Ion detector 0.00005 Amp (50  $\mu\text{A}$ ) , Optical Detector = 0.0001 Amp (100  $\mu\text{A}$ )

Typical Example:

A system comprises of 20 ionisation detectors, 14 bells and the required standby is 24 hours. It will need to operate in alarm for  $\frac{1}{2}$  hour.

Calculate the battery size required.

$$T_{\text{ALM}} = 0.5 \text{ Hr}$$

$$I_{\text{ALM}} = 14 \times 0.025 = 0.35\text{A} \quad [\text{This assumes the bell current is 25 mA. Most alarm Devices show their operating current}]$$

$$T_{\text{SBY}} = 24 \text{ Hr}$$

$$I_{\text{QP}} = 0.048\text{A}$$

$$I_{\text{QZ}} = 20 \times 0.00005 = 0.001\text{A} \quad [\text{the quiescent current for an ionisation detector is 50 } \mu\text{A}]$$

Therefore using the equation:

$$\text{Battery Size (Standby time in Amp Hours)} = 1.25 \times [(T_{\text{ALM}} \times I_{\text{ALM}}) + (T_{\text{SBY}} \times (I_{\text{QP}} + I_{\text{QZ}}))]$$

$$\text{Battery Size (Standby time in Amp Hours)} = 1.25 \times [(0.5 \times 0.35) + (24 \times (0.048 + 0.001))]$$

$$\text{Battery Size (Standby time in Amp Hours)} = 1.25 \times [0.175 + (24 \times 0.049)]$$

$$\text{Battery Size (Standby time in Amp Hours)} = 1.25 \times [0.175 + 1.176]$$

$$\text{Battery Size (Standby time in Amp Hours)} = 1.25 \times 1.351$$

$$\text{Battery Size (Standby time in Amp Hours)} = 1.69 \text{ Amp Hours}$$

This system would require a minimum of 1.69Ah batteries, so we would recommend using 2Ah batteries.

## 11. PCB TERMINATION CONNECTIONS.

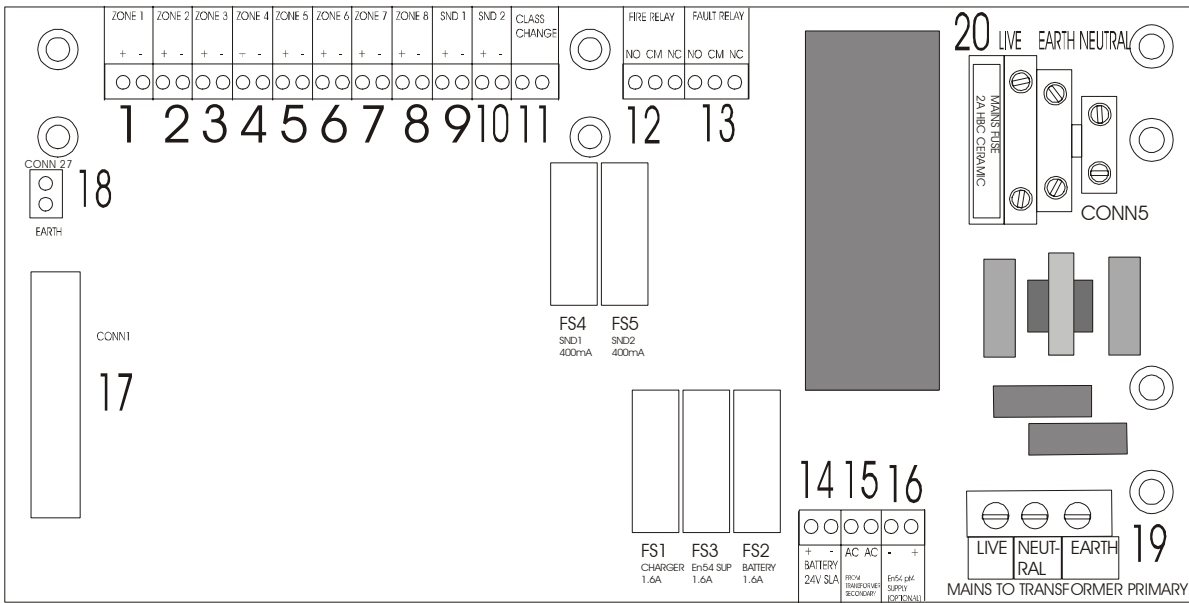

### 11.1 CONNECTIONS

Connection No	Description	Use
1	ZONE 1 +&-	Connect to Zone 1
2	ZONE 2 +&-	Connect to Zone 2
3	ZONE 3 +&-	Connect to Zone 3
4	ZONE 4 +&-	Connect to Zone 4
5	ZONE 5 +&-	Connect to Zone 5
6	ZONE 6 +&-	Connect to Zone 6
7	ZONE 7 +&-	Connect to Zone 7
8	ZONE 8 +&-	Connect to Zone 8
9	SND 1 +&-	Connect to sounder circuit 1 (sirens/bells)
10	SND 2 +&-	Connect to sounder circuit 2 (sirens/bells)
11	CLASS CHANGE	Join terminals to activate sounders
12	FIRE RELAY NO/CM/NC	Activates on fire (including test mode)
13	FAULT RELAY NO/CM/NC	Normally powered ie NO is closed with no fault
14	BATTERY + & -	Connect 2 x 12V SLA batteries in SERIES (ie 24V)
15	AC AC	Connected to transformer secondary (30VAC)
16	EN54 supply - & +	NOT CONNECTED IN STAND ALONE PANEL.
17	CONN 1	20 way ribbon cable to display PCB
18	CONN 27	EARTH connection to display PCB & SCREEN TAG
19	CONN 26	Filtered mains to transformer
20	CONN 5	MAINS TERMINAL BLOCK

### 11.2 FUSES

FUSE NO	DESCRIPTION	RATING
FS1	Charger Fuse	1.6A time delay 5 x 20mm glass
FS2	Battery Fuse	1.6A time delay 5 x 20mm glass
FS3	EN54 SUPPLY (NOT USED)	1.6A time delay 5 x 20mm glass
FS4	Sounder circuit 1	400mA time delay 5 x 20mm glass
FS5	Sounder circuit 2	400mA time delay 5 x 20mm glass
INLET FUSE	Mains Protection Fuse	2A Quick Blow HBC 5 x 20mm ceramic

## 12. PANEL SPECIFICATIONS

### 12.1 ENCLOSURE SPECIFICATIONS

DESCRIPTION	VALUE
ENCLOSURE SIZE	355 x 275 x 100 mm
TOP CABLE ENTRIES	12 x 19mm DIA GROMMETED ENTRIES
BOTTOM CABLE ENTRIES	2 x 19mm KNOCKOUT ENTRIES
REAR CABLE ENTRIES	2 SNAP OUTS, 60 x 20mm

### 12.2 ELECTRICAL SPECIFICATIONS

ELECTRICAL DESCRIPTION	VALUE
MAINS VOLTAGE	230V AC +/- 10% @ 50/60 Hz
BATTERY VOLTAGE	24V DC (2 X 12V SLA BATTERY)
SYSTEM VOLTAGE	24V DC NOMINAL (18 – 32 V)
SYSTEM VOLTAGE RIPPLE	2V PK-PK MAX
CHARGER SIZE	UP TO 7AH in 24 Hours
ZONE VOLTAGE	21V DC NOMINAL (20 - 22.5V)
SOUNDER ALARM OUTPUTS	2 x 400mA @ 24V DC (Nominal)
AUXILIARY FAULT OUTPUT	1 x RELAY SELV (1A MAX)
AUXILIARY FIRE OUTPUT	1 x RELAY SELV (1A MAX)
NUMBER OF ZONES	1/2/4/6/8
MAXIMUM ZONE CAPACITY	32 DEVICES PER ZONE
MAXIMUM ZONE RESISTANCE	70 ohms
REMOTE SOUNDER ACTIVATION	VIA N/O CONTACTS
SOUNDER ACTIVATION DELAY	0-9 MINUTES -IN 1 MIN INCREMENTS
ZONE END OF LINE DEVICE	1N4002 DIODE (CATHODE STRIPE TO +)
SOUNDER END OF LINE DEVICE	10 K RESISTOR
CHARGER VOLTAGE	28.4V @ 25°C (NO BATTERY CONNECTED)
ZONE SHORT CIRCUIT PROTECTION	100mA
CHARGER SHORT CIRCUIT PROTECTION	Batteries less than 20V
TOTAL CHARGER OUTPUT	1.1 Amp